

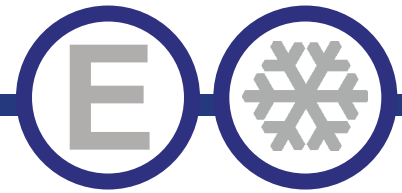

Series "B"



Undercounter Refrigerator Units



Model	Size
EUR27X	27" Unit
EUR36X	36" Unit
EUR47X	47" Unit
EUR60X	60" Unit
EUR72X	72" Unit

STANDARD FEATURES

- Stainless steel exterior, aluminum interior and back.
- Stainless Interior available - add suffix "-SI" to the model number. i.e. EUR27X-SI
- Refrigeration system keeps food at safe temperatures between 33°F and 41°F
- Self-Closing doors with 90 degree stay-open feature.
- Shelves: Adjustable heavy-duty PVC coated shelves.
- Electronic control system makes it easy to adjust temperature set point and defrost frequency.
- Pre-installed 4" swivel casters with brakes.
- Easy to access condenser coil for cleaning and service.
- Uses R290 refrigerant, which is eco-friendly and more efficient.
- Warranty: Two year parts & labor warranty, and additional three years on compressor.

*Not suitable for installation in a non-commercial or residential applications.

Items	Description	Items	Description
Front, top & sides	Stainless steel	Temperature control	Solid state thermostat/Digital display
Doors	Stainless steel	Approvals	ETL LISTED
External back	Aluminum	Refrigerating system	Capillary tube
Cabinet interior	Aluminum	Refrigerant	R290
Interior floor	Stainless steel	Temperature range	33°F to 41°F
Insulation	Polyurethane (CFC free)	Evaporator	Powder coated aluminum/copper
Shelves	Heavy duty, PVC coating	Condensing unit	Bottom mounted

CONFORMS TO NSF/ANSI STD 7

REFRIGERATION





DETAILS AND DIMENSIONS

Side View Same For All

EUR27X

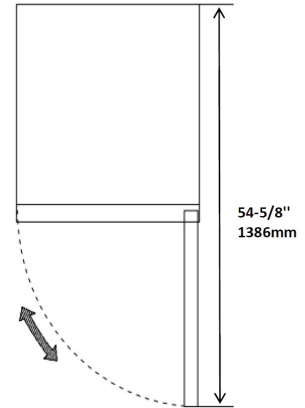
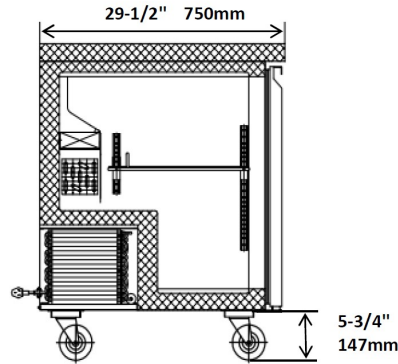
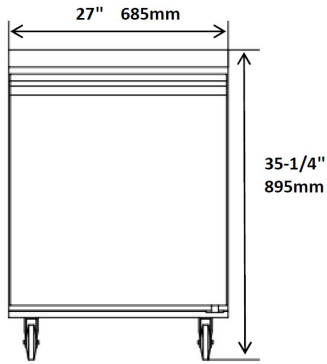

EUR36X

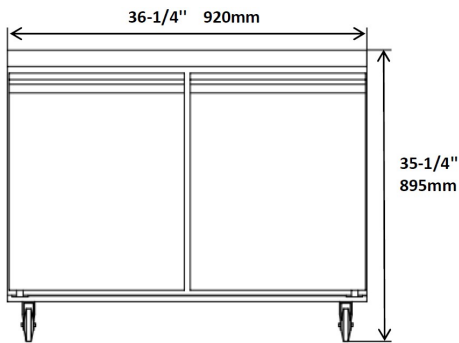

EUR36X & EUR47X

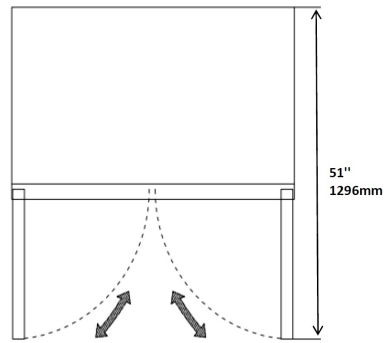

EUR47X

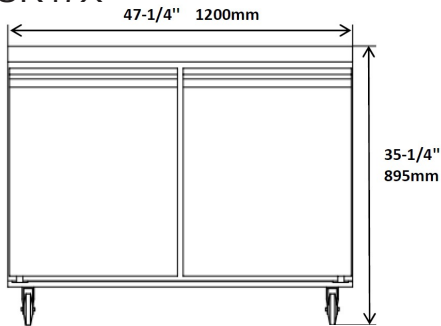

EUR60X

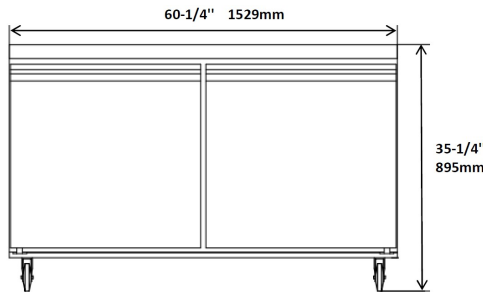

EUR60X

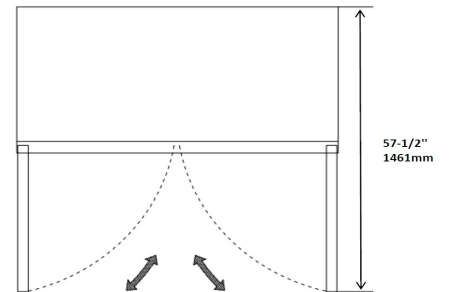

EUR72X

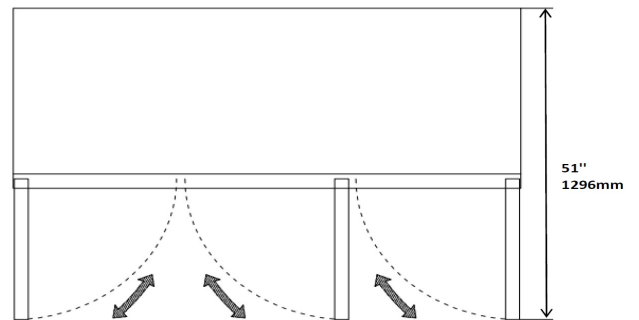
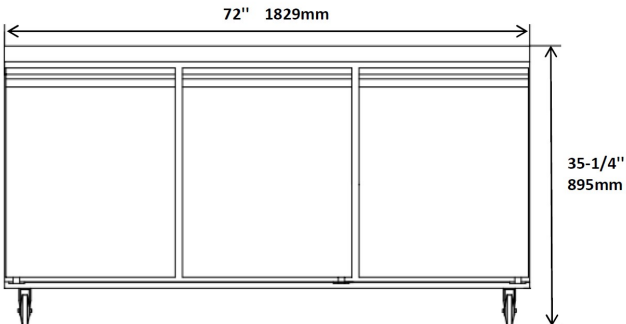

Model	Doors	Shelves	Cabinet Dim (inches)			HP	Voltage	Amps	NEMA Plug	Cord Length	Ship Weight
			L	D	H						
EUR27X	1	1	27	29.5	35.25	1/6	115/60/1	1.9	5-15P	10	220
EUR36X	2	2	36.25	29.5	35.25	1/6	115/60/1	2.3	5-15P	10	242
EUR47X	2	2	47.25	29.5	35.25	1/5	115/60/1	2.7	5-15P	10	299
EUR60X	2	2	60.2	29.5	35.25	1/5	115/60/1	2.9	5-15P	10	341
EUR72X	3	3	72	29.5	35.25	3/5	115/60/1	3.2	5-15P	10	407