



SLIDE TOP BOTTLE COOLER

MODELS: BST-36-HC, BST-50HC,
BST-65-HC AND BST-94-HC



Phone 704-200-2068

www.entree.biz

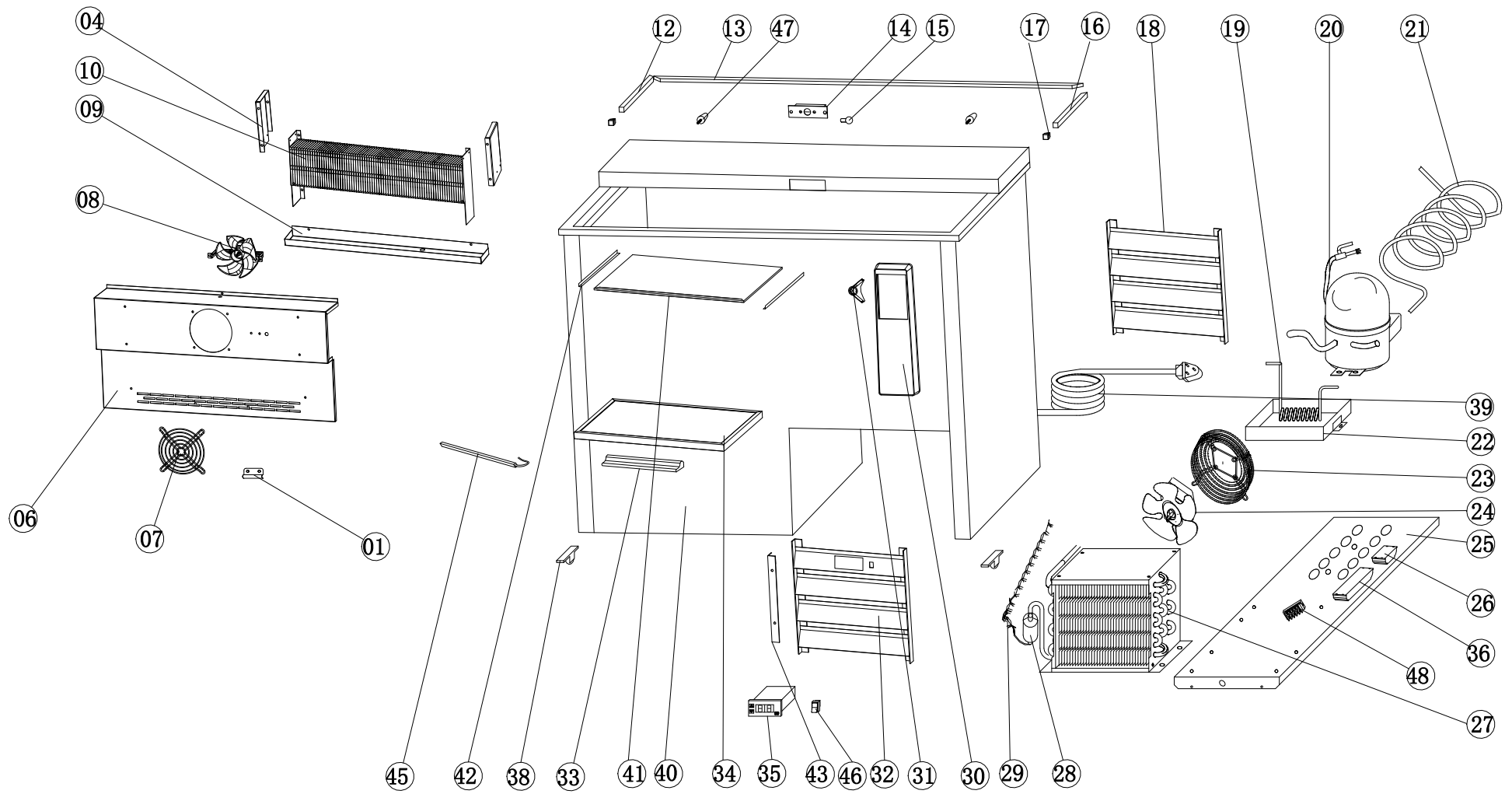

MODEL: BST-36-HC

MODEL BST-36-HC

NO	ENTRÉE #	NAME	QTY
1	BD0053	PROBE BRACKET	1
4	NA	EVAPORATOR SUPPORT BRACKET RIGHT	
4	NA	EVAPORATOR SUPPORT BRACKET LEFT	
6	BST0036	EVAPORATOR COVER	1
7	BC30910	EVAPORATOR FAN GUARD	1
8	HC0116	EVAPORATOR FAN MOTOR YZF10-20 (DC 13V, 4W 0.35A, CW,	1
9	BC30922	EVAPORATOR DRIP PAN	1
10	BC50036	EVAPORATOR	1
12	N/A	LEFT STRIP	
12	N/A	LEFT STRIP	
13	N/A	BACK STRIP	
13	N/A	BACK STRIP	
14	BC30909	LOCK BOX	1
14	N/A		
15	BC30704	LOCK	1
16	N/A	RIGHT STRIP	
16	N/A	RIGHT STRIP	
17	N/A	CLIP	
18	BC30916	REAR LOUVERED PANEL	1
19	BC30942	EVAPORATOR PIPE	1
20	H00029F	COMPRESSOR W/FILTER DRIER (HDL125D)	1
20	H00029K	START KIT FOR HDL125D	*
21	BC30940	SUCTION PIPE	1
22	GF0010	CONDENSER WATER BOX	1
23	HC0111	CONDENSER FAN GUARD	1
24	HC00110	CONDENSER FAN	1
25	N/A	CONDENSER SUPPORT PANEL	
26	BC00036	LED POWER SUPPLY	1
27	HC1347	CONDENSER COIL	1
28	RD0341	FILTER DRIER	1
29	H01301	CAPILLARY TUBE ID .039"X L 118.1"	1
30	BC30903	BOTTLE CAP BOX	1
31	BC30902	BOTTLE OPENER	1
32	BC30917	FRONT LOUVERED PANEL	1
33	BC30908	HANDLE	2
34	BC30036	SLIDING DOOR (BST)	2
35	H00205	TEMPERATURE SENSOR NTC TYPE (5' LENGTH)	2
35	H00219	CONTROLLER	1
36	BC0044C	Led Power Supply	1
38	BC1316	1' ROLLER WHEEL	4
39	C2194684	POWER CORD, 14AWG/NEMA 5-15P	1
40	N/A	CABINET	
41	N/A	INSULLATING PANEL	
42	N/A	PANEL SUPPORT	
42	N/A	PANEL SUPPORT	
43	N/A	MOUNTING BRACKET	
43	N/A	MOUNTING BRACKET	
45	BC00037	LED LAMP	1
46	C2197462	LIGHT SWITCH	1
47	H02315	REAR WALL SPACER	2
48	H00215	TERMINAL BLOCK, 5 POLE	1

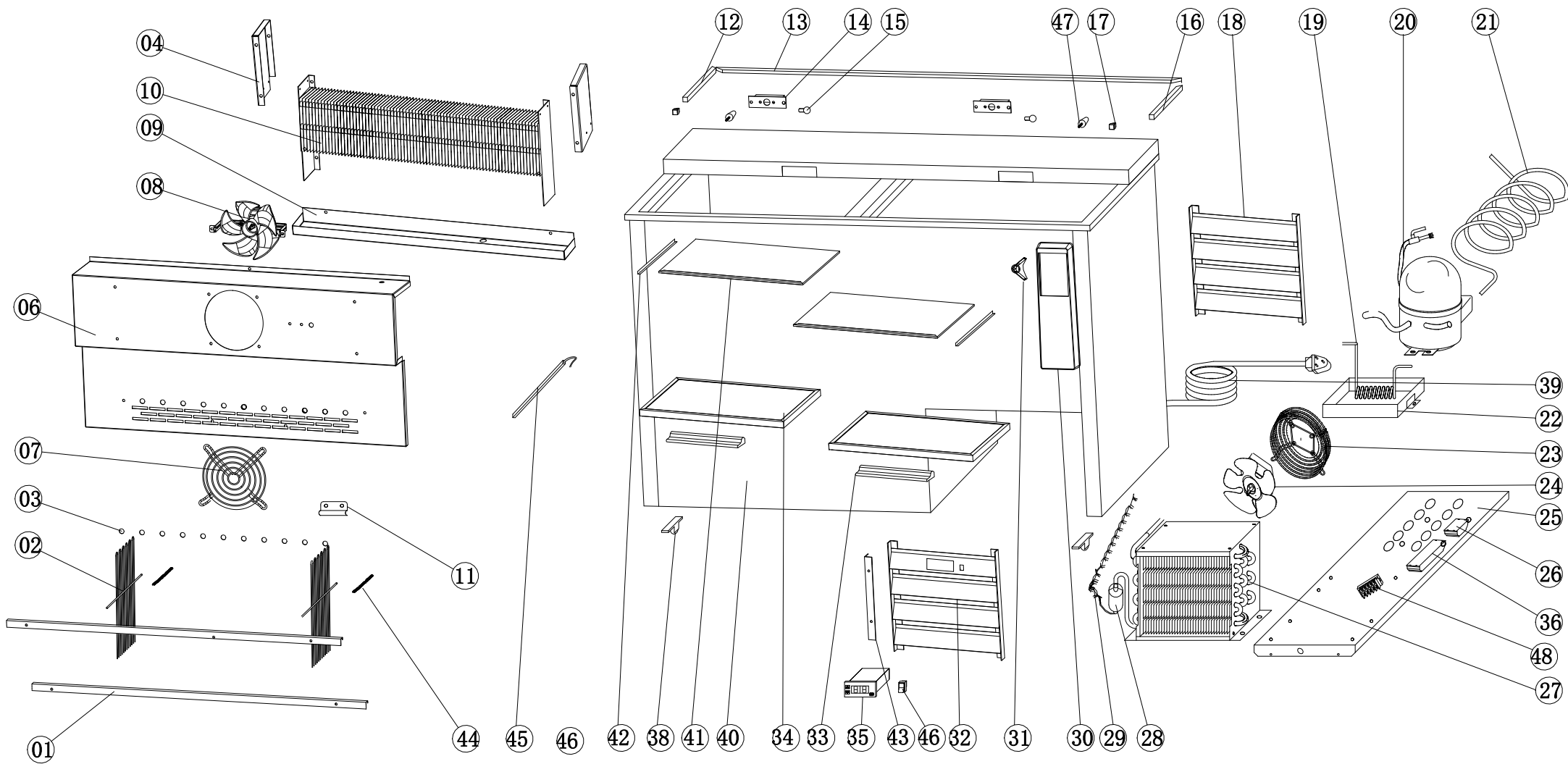

MODEL: BST-50-HC

MODEL BST-50-HC

NO	ENTRÉE #	NAME	QTY
1	N/A	SUPPORT BRACKET	2
2	BC30913	DIVIDER	2
3	BC30914	SHELF PROTECTOR PIN	32
4	NA	EVAPORATOR SUPPORT BRACKET RIGHT	
4	NA	EVAPORATOR SUPPORT BRACKET LEFT	
6	BST0050	EVAPORATOR COVER	1
7	BC30910	EVAPORATOR FAN GUARD	1
8	HC0116	EVAPORATOR FAN MOTOR YZF10-20 (DC 13V, 4W 0.35A, CW,	1
9	BC30906	EVAPORATOR DRIP PAN	1
10	BC50050	EVAPORATOR	1
11	BD0053	PROBE BRACKET	1
12	BC1000	LEFT STRIP	1
13	BC1050	BACK STRIP	1
14	BC30909	LOCK BOX	2
14	N/A		
15	BC30704	LOCK	2
16	BC1001	RIGHT STRIP	1
17	N/A	CLIP	
18	BC30916	REAR LOUVERED PANEL	1
19	BC30942	EVAPORATOR PIPE	1
20	H00034F	COMPRESSOR W/FILTER DRIER (HDL140D)	1
20	H00227	START KIT FOR HDL140D	*
21	BC30940	SUCTION PIPE	1
22	GF0010	CONDENSER WATER BOX	1
23	HC0111	CONDENSER FAN GUARD	1
24	HC00110	CONDENSER FAN	1
25	N/A	CONDENSER SUPPORT PANEL	
26	BC00036	LED POWER SUPPLY	1
27	HC1347	CONDENSER COIL	1
28	RD0341	FILTER DRIER	1
29	H01301	CAPILLARY TUBE ID .039"X L 118.1"	1
30	BC30903	BOTTLE CAP BOX	1
31	BC30902	BOTTLE OPENER	1
32	BC30917	FRONT LOUVERED PANEL	1
33	BC30908	HANDLE	2
34	BC30027	SLIDING DOOR (BST)	2
35	H00205	TEMPERATURE SENSOR NTC TYPE (5' LENGTH)	2
35	H00219	CONTROLLER	1
36	BC0044C	Led Power Supply	1
38	BC1316	1' ROLLER WHEEL	4
39	C2194684	POWER CORD, 14AWG/NEMA 5-15P	1
40	N/A	CABINET	
41	N/A	INSULLATING PANEL	
42	N/A	PANEL SUPPORT	
43	N/A	MOUNTING BRACKET	
44	BC30918	SPRING	2
45	BC00037	LED LAMP	1
46	C2197462	LIGHT SWITCH	1
47	H02315	REAR WALL SPACER	2
48	H00215	TERMINAL BLOCK, 5 POLE	1

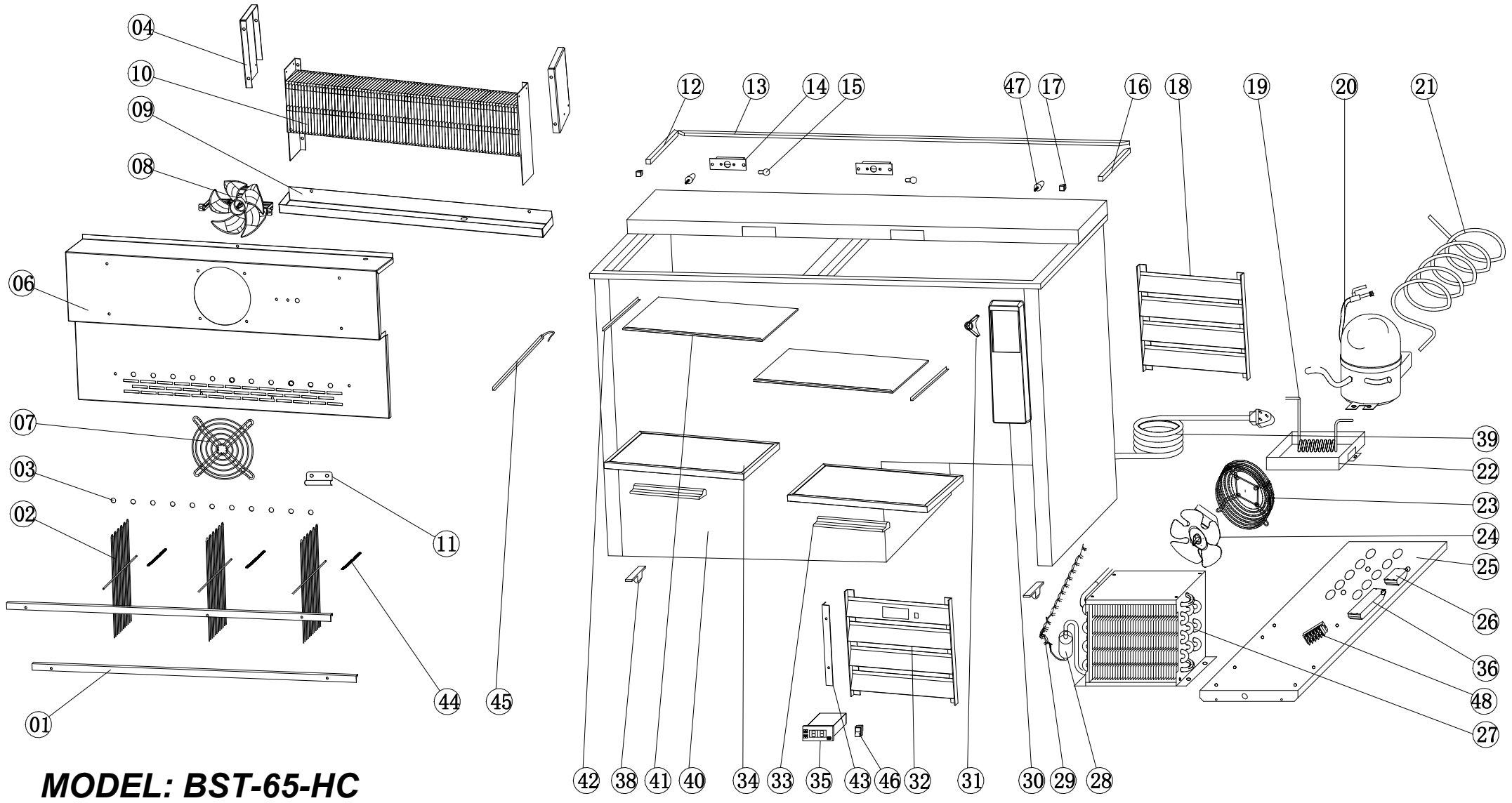

MODEL: BST-65-HC

MODEL BST-65-HC

NO	ENTRÉE #	NAME	QTY
1	N/A	SUPPORT BRACKET	2
2	BC30913	DIVIDER	3
3	BC30914	SHELF PROTECTOR PIN	41
4	NA	EVAPORATOR SUPPORT BRACKET RIGHT	
4	NA	EVAPORATOR SUPPORT BRACKET LEFT	
6	BST0065	EVAPORATOR COVER	1
7	BC30910	EVAPORATOR FAN GUARD	1
8	HC0116	EVAPORATOR FAN MOTOR YZF10-20 (DC 13V, 4W 0.35A, CW,	1
9	BC30907	EVAPORATOR DRIP PAN	1
10	BC50065	EVAPORATOR	1
11	BD0053	PROBE BRACKET	1
12	N/A	LEFT STRIP	
12	N/A	LEFT STRIP	
13	N/A	BACK STRIP	
13	N/A	BACK STRIP	
14	BC30909	LOCK BOX	2
15	BC30704	LOCK	2
16	N/A	RIGHT STRIP	
16	N/A	RIGHT STRIP	
17	N/A	CLIP	
18	BC30916	REAR LOUVERED PANEL	1
19	BC30942	EVAPORATOR PIPE	1
20	H00034F	COMPRESSOR W/FILTER DRIER (HDL140D)	1
20	H00227	START KIT FOR HDL140D	*
21	BC30940	SUCTION PIPE	1
22	GF0010	CONDENSER WATER BOX	1
23	HC0111	CONDENSER FAN GUARD	1
24	HC00110	CONDENSER FAN	1
25	N/A	CONDENSER SUPPORT PANEL	
26	BC00036	LED POWER SUPPLY	1
27	HC1347	CONDENSER COIL	1
28	RD0341	FILTER DRIER	1
29	H01301	CAPILLARY TUBE ID .039"X L 118.1"	1
30	BC30903	BOTTLE CAP BOX	1
31	BC30902	BOTTLE OPENER	1
32	BC30917	FRONT LOUVERED PANEL	1
33	BC30908	HANDLE	2
34	BC30028	SLIDING DOOR (BST)	2
35	H00219	CONTROLLER	1
35	H00205	TEMPERATURE SENSOR NTC TYPE (5' LENGTH)	2
36	BC0044C	Led Power Supply	1
38	BC1316	1' ROLLER WHEEL	4
39	C2194684	POWER CORD, 14AWG/NEMA 5-15P	1
40	N/A	CABINET	
41	N/A	INSULLATING PANEL	
42	N/A	PANEL SUPPORT	
42	N/A	PANEL SUPPORT	
43	N/A	MOUNTING BRACKET	
43	N/A	MOUNTING BRACKET	
44	BC30918	SPRING	3
45	BC00037	LED LAMP	1
46	C2197462	LIGHT SWITCH	1
47	H02315	REAR WALL SPACER	2
48	H00215	TERMINAL BLOCK, 5 POLE	1

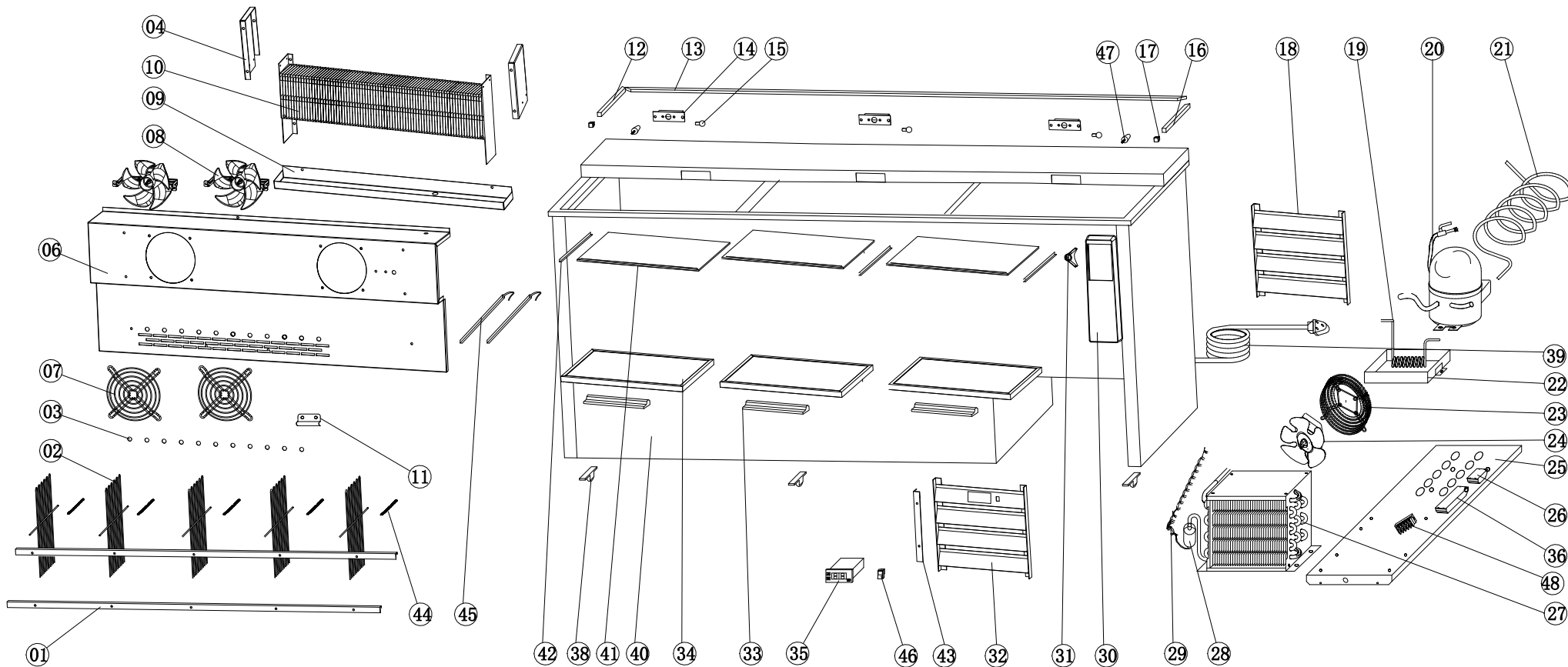

MODEL: BST-94-HC

MODEL BST-94-HC

NO	ENTRÉE #	NAME	QTY
1	N/A	SUPPORT BRACKET	4
2	BC30913	DIVIDER	5
3	BC30914	SHELF PROTECTOR PIN	72
4	NA	EVAPORATOR SUPPORT BRACKET RIGHT	
6	BST0094	EVAPORATOR COVER	1
7	BC30910	EVAPORATOR FAN GUARD	2
8	HC0116-4	EVAPORATOR FAN MOTOR (BLDC 2200)	2
9	BC30923	EVAPORATOR DRIP PAN	1
10	BC50094	EVAPORATOR	1
11	BD0053	PROBE BRACKET	1
12	N/A	LEFT STRIP	
13	N/A	BACK STRIP	
13	N/A	BACK STRIP	
14	BC30909	LOCK BOX	2
15	BC30704	LOCK	2
16	N/A	RIGHT STRIP	
17	N/A	CLIP	
18	BC30916	REAR LOUVERED PANEL	1
19	BC30941	EVAPORATOR PIPE	1
20	H00038F	COMPRESSOR W/FILTER DRIER (NUG45LR)	1
20	HC0038K	START KIT FOR NUG45LR	*
21	BC30940	SUCTION PIPE	1
22	GF0010	CONDENSER WATER BOX	1
23	HC0111	CONDENSER FAN GUARD	1
24	HC00110	CONDENSER FAN	1
25	N/A	CONDENSER SUPPORT PANEL	
26	BC00036	LED POWER SUPPLY	1
27	HC1347	CONDENSER COIL	1
28	RD0341	FILTER DRIER	1
29	H01301	CAPILLARY TUBE ID .039"X L 118.1"	1
30	BC30903	BOTTLE CAP BOX	1
31	BC30902	BOTTLE OPENER	1
32	BC30917	FRONT LOUVERED PANEL	1
33	BC30908	HANDLE	2
34	BC30094	SLIDING DOOR (BST)	2
35	H00219	CONTROLLER	1
35	H00205	TEMPERATURE SENSOR NTC TYPE (5' LENGTH)	2
36	G10006	LED POWER SUPPLY	1
38	BC1316	1' ROLLER WHEEL	6
39	C2194684	POWER CORD, 14AWG/NEMA 5-15P	1
40	N/A	CABINET	
41	N/A	INSULLATING PANEL	
42	N/A	PANEL SUPPORT	
43	N/A	MOUNTING BRACKET	
44	BC30918	SPRING	5
45	BC00037	LED LAMP	2
46	C2197462	LIGHT SWITCH	1
47	H02315	REAR WALL SPACER	2
48	H00215	TERMINAL BLOCK, 5 POLE	1



For Tech Support or Parts Call:
1-704-900-2068

Website: <https://www.entree.biz>