



# Back Bar Bottle Cooler

## Service, Installation and Care Manual

**Please read this manual completely before attempting to install or operate this equipment.  
Notify carrier of damage! Inspect all components immediately.**



**IMPORTANT INFORMATION  
READ BEFORE USE  
PLEASE SAVE THESE INSTRUCTIONS!**

## COMMERCIAL REFRIGERATOR SAFETY

**Your safety and the safety of others are very important.**

We have provided many important safety messages in this manual and on your appliance. Always read and obey all safety messages.

**Our product instructions will be uploaded on our company official website.**



This is the Safety Alert Symbol. This symbol alerts you to potential hazards that can kill or injure you and others. All safety messages will follow the Safety Alert Symbol and either the words "DANGER", "WARNING" or "CAUTION".



Danger means that failure to heed this safety statement may result in severe personal injury or death.



Warning means that failure to heed this safety statement may result in extensive product damage, serious personal injury, or death.



Caution means that failure to heed this safety statement may result in minor or moderate personal injury, or property or equipment damage.

All safety messages will alert you to what the potential hazard is, tell you how to reduce the chance of injury, and let you know what can happen if the instructions are not followed.

If the supply cord is damaged, it must be replaced by the manufacturer, its service agent or similarly qualified persons in order to avoid a hazard.

This appliance is not intended for use by persons (including children) with reduced physical, sensory or mental capabilities, or lack of experience and knowledge, unless they have been given supervision or instruction concerning use of the appliance by a person responsible for their safety.

Children should be supervised to ensure that they do not play with the appliance.

This appliance can be used by children aged from 8 years and above and persons with reduced physical sensory or mental capabilities or lack of experience and knowledge if they have been given supervision or instruction concerning use of the appliance in a safe way and understand the hazards involved. Children shall not play with the appliance. Cleaning and user maintenance shall not be made by children without supervision.

Keep the appliance and its cord out of reach of children less than 8 years.

Do not store explosive substances such as aerosol cans with a flammable propellant in this appliance.

The appliance use flammable insulation blowing gas C5H10, disposal of the appliance shall in accordance with the regulations of local authorities.

The key for appliance electric box should be safe kept by qualified persons in order to avoid a hazard



Warning; Risk of fire / flammable materials

**WARNING:** Keep ventilation openings, in the appliance enclosure or in the built-in structure, clear of obstruction.

**WARNING:** Do not use mechanical devices or other means to accelerate the defrosting process, other than those recommended by the manufacturer.

**WARNING:** Do not damage the refrigerant circuit.

**WARNING:** Do not use electrical appliances inside the food storage compartments of the appliance, unless they are of the type recommended by the manufacturer.

Handling, moving, and use of the refrigerator or freezer to avoid either damaging the refrigerant tubing, or increasing the risk of a leak

L'opération, le mouvement et l'utilisation du réfrigérant ou le congélateur doivent éviter les dommages du tuyau réfrigérant ou le risque de la fuite.

Caution – Risk of Fire or Explosion due to Flammable Refrigerant Used. Follow Handling Instructions Carefully in Compliance with U.S. Government Regulations.

Component parts shall be replaced with like components and that servicing shall be done by factory authorized service personnel, so as to minimize the risk of possible ignition due to incorrect parts or improper service.

Les pièces de rechange doivent être remplacées par les composants relatifs et les opérations doivent être faites par les professionnels afin de minimaliser le risque d'allumage à cause des parts incorrects ou des opérations impropres.

CAUTION – Risk Of Fire Or Explosion Due To Puncture Of Refrigerant Tubing; Follow Handling Instructions Carefully. Flammable Refrigerant Used

**DANGER:** Risk of child entrapment. Before you throw away your old refrigerator or freezer:

Take off the doors

Leave the shelves in place so that children may not easily climb inside.



# CONTENTS

RECEIVING & INSPECTING EQUIPMENT.....4

SPECIFICATIONS.....5

INSTALLATION.....6

OPERATION.....7

MAINTENANCE.....9

CIRCUIT DIAGRAM.....11

All rights reserved. Reproduction without written permission is prohibited.



is a registered trademark of The Entree Company.

# SERIAL NUMBER INFORMATION

The serial number of all self-contained refrigerators is located inside the unit on the left hand side near the top on the wall.

Always have the serial number of your unit available when calling for parts or service.

This manual covers standard units only. If you have a custom unit, consult the customer service department at the number listed on the last page.

# RECEIVING AND INSPECTING THE EQUIPMENT

Even though most equipment is shipped crated, care should be taken during unloading so the equipment is not damaged while being moved into the building.

1. Visually inspect the exterior of the package and skid or container. Any damage should be noted and reported to the delivering carrier immediately.
2. If damaged, open and inspect the contents with the carrier.
3. In the event that the exterior is not damaged, yet upon opening, there is concealed damage to the equipment, notify the carrier. Notification should be made verbally as well as in written form.
4. Request an inspection by the shipping company of the damaged equipment. This should be done within 10days from receipt of the equipment.
5. Be certain to check the compressor compartment housing and visually inspect the refrigeration package. Be sure lines are secure and base is still intact.
6. Freight carriers can supply the necessary damage forms upon request.
7. Retain all crating material until an inspection has been made or waived.





## SPECIFICATION

BACK BAR BOTTLE COOLER								
MODEL#	V/Hz/Ph	AMPS	STORAGE CAPACITY	HP	BTU	CHARGE OZ	SHIP WEIGHT LBS	NEMA PLUG
BB-2D-60-HC	115/60/1	3	13.8	3/8	3200	3.88	302	5-15P
BB-2D-70-HC	115/60/1	3	14.5	3/8	3200	3.88	355	5-15P
BB-3D-90-HC	115/60/1	3	25.3	1/2	5800	4.59	412	5-15P
BB-2D-60-G-HC	115/60/1	3	13.8	3/8	3200	3.88	353	5-15P
BB-2D-70-G-HC	115/60/1	3	14.5	3/8	3200	3.88	395	5-15P
BB-3D-90-G-HC	115/60/1	3	25.3	1/2	5800	4.59	474	5-15P

BACK BAR BOTTLE COOLER								
MODEL#	V/Hz/Ph	AMPS	STORAGE CAPACITY	HP	BTU	CHARGE OZ	SHIP WEIGHT LBS	NEMA PLUG
BB-2D-60-SI-HC	115/60/1	3	13.8	3/8	3200	3.88	302	5-15P
BB-2D-70-SI-HC	115/60/1	3	14.5	3/8	3200	3.88	355	5-15P
BB-3D-90-SI-HC	115/60/1	3	25.3	1/2	5800	4.59	412	5-15P
BB-2D-60-G-SI-HC	115/60/1	3	13.8	3/8	3200	3.88	353	5-15P
BB-2D-70-G-SI-HC	115/60/1	3	14.5	3/8	3200	3.88	395	5-15P
BB-3D-90-G-SI-HC	115/60/1	3	25.3	1/2	5800	4.59	474	5-15P



## INSTALLATION

### Location

Units represented in this manual are intended for indoor use only. Be sure the location chosen has a floor strong enough to support the total weight of the cabinet and contents. A fully loaded unit can weigh as much as 1500 pounds. Reinforce the floor as necessary to provide for maximum loading. For the most efficient refrigeration, be sure to provide good air circulation inside and out.

### Inside cabinet:

Do not pack refrigerator so full that air cannot circulate. The refrigerated air is discharged at the top rear of the unit. It is important to allow for proper air flow from the top rear to the bottom of the unit. Obstructions to this air flow can cause evaporator coil freeze ups and loss of temperature or overflow of water from the evaporator drain pan. The shelves have a rear turn up on them to prevent this. However, bags and other items can still be located to the far rear of the cabinet. Air is brought into the evaporator coil with fans mounted to the front of the coil. Prevent obstruction by locating large boxes and tall stacks of product to the bottom of the cabinet.

### Outside cabinet:

Be sure that the unit has access to ample air. Avoid hot corners and locations near stoves and ovens. It is recommended that the unit be installed no closer than 2" from any wall with at least 12" of clear space above the unit. Should it become necessary to lay the unit on its side or back for any reason, allow at least 24 hours before start-up so as to allow compressor oil to flow back to the sump. Failure to meet this requirement can cause compressor failure and unit damage.

### Leveling

A level cabinet looks better and will perform better because the doors will line up with the frames properly, the cabinet will not be subject to undue strain and the contents of the cabinet will not move around on the shelves. Use a level to make sure the unit is level from front to back and side to side. Units supplied with legs will have adjustable bullet feet to make the necessary adjustments. If the unit is supplied with casters, no adjustments are available. Ensure the floor where the unit is to be located is level.

### Stabilizing

Models are supplied on casters for your convenience, ease of cleaning underneath and for mobility. It is very important, however, that the cabinet be installed in a stable condition with the front wheels locked while in use.



**NOTE**

**Standard warranties will be voided due to improper installation procedures.**

### Electrical connection

Refer to the amperage data on page 5, the serial tag, your local code or the National Electrical Code to be sure the unit is connected to the proper power source. A protected circuit of the correct voltage and amperage must be run for connection of the line cord, or permanent connection to the unit.



**DANGER**

**The ON/OFF switch must be turned to OFF and the unit disconnected from the power source whenever performing service, maintenance functions or cleaning the refrigerated area.**

## OPERATION



**CAUTION**

Do not throw items into the storage area. Failure to heed these recommendations could result in damage to the interior of the cabinet.

**Refrigerators:** The factory setting for temperature range is 34°F-38°F

**Light Switch:**

A light switch is located next to on/off switch on the front of the bottom shroud.



**Defrosting:** This unit will automatically go into defrost six times every 24 hour period. To put the unit into manual defrost see instructions below.

## SOLID-STATE THERMOSTAT DESCRIPTIONS





### 1. FRONT PANEL COMMANDS



**SET:** To display target set point; in programming mode it selects a parameter or confirms an operation.

-  **(DEF)** To start a manual defrost
-  **(UP)** To view the last alarm occurrence; in programming mode, it browses the parameter codes or increases the display value
-  **(DOWN)** To view the last alarm occurrence; in programming mode, it browses the parameter codes or decreases the display value

**KEY COMBINATION**

-  +  To lock & unlock the keyboard
- SET** +  To enter in programming mode
- SET** +  To return to the room temperature display

# OPERATION

## 1.1 Function of LEDS

LED	MODE	FUNCTION
	ON	Compressor enabled
	Flashing	-Programming Phase (flashing with ) - Anti-short cycle delay enabled
	ON	Defrost enabled
	Flashing	- Programming Phase (flashing with ) - Drip time in progress
	ON	An temperature alarm happened

## 2. MAIN FUNCTIONS

### 2.1 HOW TO SEE THE SETPOINT

1. Push and immediately release the **SET** key: the display will show the set point value.
2. Push and immediately release the **SET** key or wait for 5 seconds to display the sensor value again.

### 2.2 HOW TO CHANGE THE SETPOINT

1. Push the **SET** key for more than 2 seconds to change the set point value.
2. The value of the set point will be displayed and the LED starts blinking.
3. To change the set value push the or key within 10s.
4. To set new point value, push the SET key again or wait 10s.



### 2.3 HOW TO START A MANUAL DEFFROST

Push the key for more than 2 seconds and a manual defrost will start



### 2.4 HOW TO LOCK THE KEYBOARD

1. Hold the and keys for more than 3s.
2. The "POF" message will be displayed and the keyboard will be locked. At this point, it will be possible only to see the set point or the MAX or Min temperature stored.
3. If a key is pressed more than 3s the "POF" message will be displayed.



### 2.5 HOW TO UNLOCK THE KEYBOARD

Hold the and keys together for more than 3s, till the "POF" message is displayed.

## 3.ALARM SIGNALS

### HOW TO SEE THE ALARM AND RESET THE RECORDED ALARM

1. Hold the or key to display the alarm signals.
2. When the signal is displayed, hold the **SET** key until the "rst" message is displayed. Push the **SET** key again. The "rst" message will start blinking and the normal temperature will be displayed again.

Message	Cause	Outputs
"P1"	Room probe failure	Compressor output according to par. "Con" and "COF"
"P2"	Evaporator probe failure	Defrost end is timed
"HA"	Maximum temperature alarm	Outputs unchanged.
"LA"	Minimum temperature alarm	Outputs unchanged.
"dA"	Door open	Regulation restarts
"EA"	External alarm	Output unchanged.
"CA"	Serious external alarm (i1F=bAL)	All outputs OFF.
"CA"	Pressure switch alarm (i1F=PAL)	All outputs OFF



## MAINTENANCE



**DANGER**

**The power switch must be turned OFF and the unit disconnected from the power source whenever performing service, maintenance functions or cleaning the refrigerated area.**

The interior and exterior can be cleaned using soap and warm water. If this isn't sufficient, try ammonia and water or a nonabrasive liquid cleaner. When cleaning the exterior, always rub with the "grain" of the stainless steel to avoid marring the finish.

Do not use an abrasive cleaner because it will scratch the stainless steel and plastic and can damage the breaker strips and gaskets.

### **Cleaning the Condenser Coil**

The condenser coil requires regular cleaning. Cleaning is recommended every 90 days. In some instances, you may find that there is a large amount of debris and dust or grease accumulated prior to the 90 day time frame. In these cases the condenser coil should be cleaned every 30 days.

If the build up on the coil consists of only light dust and debris, the condenser coil can be cleaned with a simple brush. Heavier dust build-up may require a vacuum or even compressed air to blow through the condenser coil.

If heavy grease is present, there are de-greasing agents available for refrigeration use and specifically for the condenser coils. The condenser coil may require cleaning with the de-greasing agent and then blown through with compressed air.

Failure to maintain a clean condenser coil can initially cause high temperatures and excessive run times. Continuous operation with dirty or clogged condenser coils can result in compressor failures. Neglecting the condenser coil cleaning procedures will void any warranties associated with the compressor or cost to replace the compressor.



**DANGER**

**Never use a high pressure water wash for this cleaning procedure as water can damage the electrical components located near or at the condenser coil.**

In order to maintain proper refrigeration performance, the condenser fins must be cleaned of dust, dirt and grease regularly. It is recommended that this be done at least every three months. If conditions are such that the condenser is totally blocked in three months, the frequency of cleaning should be increased. Clean the condenser with a vacuum cleaner or stiff brush. If extremely dirty, a commercial-grade condenser cleaner may be required.

### **Stainless Steel Care and Cleaning**

To prevent discoloration of rust on stainless steel, several important steps need to be taken. First, we need to understand the properties of stainless steel. Stainless steel contains 70-80% iron which will rust. It also contains 12-30% chromium which forms an invisible passive film over the steel's surface which acts as a shield against corrosion. As long as the protective layer is intact, the metal is still stainless. If the film is broken or contaminated, outside elements can begin to breakdown the steel and begin to form rust or discoloration. Proper cleaning of stainless steel requires soft cloths or plastic scouring pads.



**DANGER**

**NEVER USE STEEL PADS, WIRE BRUSHES OR SCRAPERS!**

## MAINTENANCE

Cleaning solutions need to be alkaline based or non-chloride based. Any cleaner containing chlorides will damage the protective film of the stainless steel. Chlorides are commonly found in hard water, salts, and household and industrial cleaners. If cleaners containing chlorides are used, be sure to rinse and dry thoroughly.

Routine cleaning of stainless steel can be done with soap and water. Extreme stains or grease should be cleaned with a non-abrasive cleaner and plastic scrub pad. It is always good to rub with the grain of the steel. There are also stainless steel cleaners available which can restore and preserve the finish of the steels protective layer.

Early signs of stainless steel breakdown can consist of small pits and cracks. If this has begun, clean thoroughly and start to apply stainless steel cleaners in attempt to restore the passivity of the steel.



**CAUTION**

**Never use an acid based cleaning solution! Many food products have an acidic content which can deteriorate the finish. Be sure to clean the stainless steel surfaces of ALL food products.**

### Gasket Maintenance

Gaskets require regular cleaning to prevent mold and mildew build up and also to keep the elasticity of the gasket. Gasket cleaning can be done with the use of warm soapy water. Avoid full strength cleaning products on gaskets as this can cause them to become brittle and prevent proper seals. Do not use sharp tools or knives to scrape or clean the gasket which could possibly tear the gasket and rip the bellows.

Gaskets can easily be replaced and don't require the use of tools or authorized service technicians. The gaskets are "Dart" style and can be pulled out of the grove in the door and replaced by pressing the new one back into place.

### Doors/Hinges

Over time and with heavy use, door hinges may become loose. If the door is beginning to sag, tighten the screws that mount the hinge brackets to the frame of the unit. If the doors are loose or sagging this can cause the hinge to pull out of the frame which may damage to both the doors and the door hinges.

### Drain Maintenance

Each unit has a drain located inside the unit which removes the condensation from the evaporator coil and evaporates it into an external condensate evaporator pan. Each drain can become loose or disconnected from moving or bumping the drain. If you notice excessive water accumulation on the inside of the unit, be sure the drain tube is connected from the evaporator housing to the condensate evaporator drain pan. If water starts to collect underneath the unit, you may want to check the condensate evaporator drain tube to be sure it is still located inside the drain pan. The leveling of the unit is important as the units are designed to drain properly when on a level surface. If your floor is not level this can also cause drain problems. Be sure all drain lines are free of obstructions because this may cause water to back up and overflow the drain pans.

# CIRCUIT DIAGRAM

MODEL:BB-2D-60/BB-2D-70/BB-2D-60-SI/BB-2D-70-SI

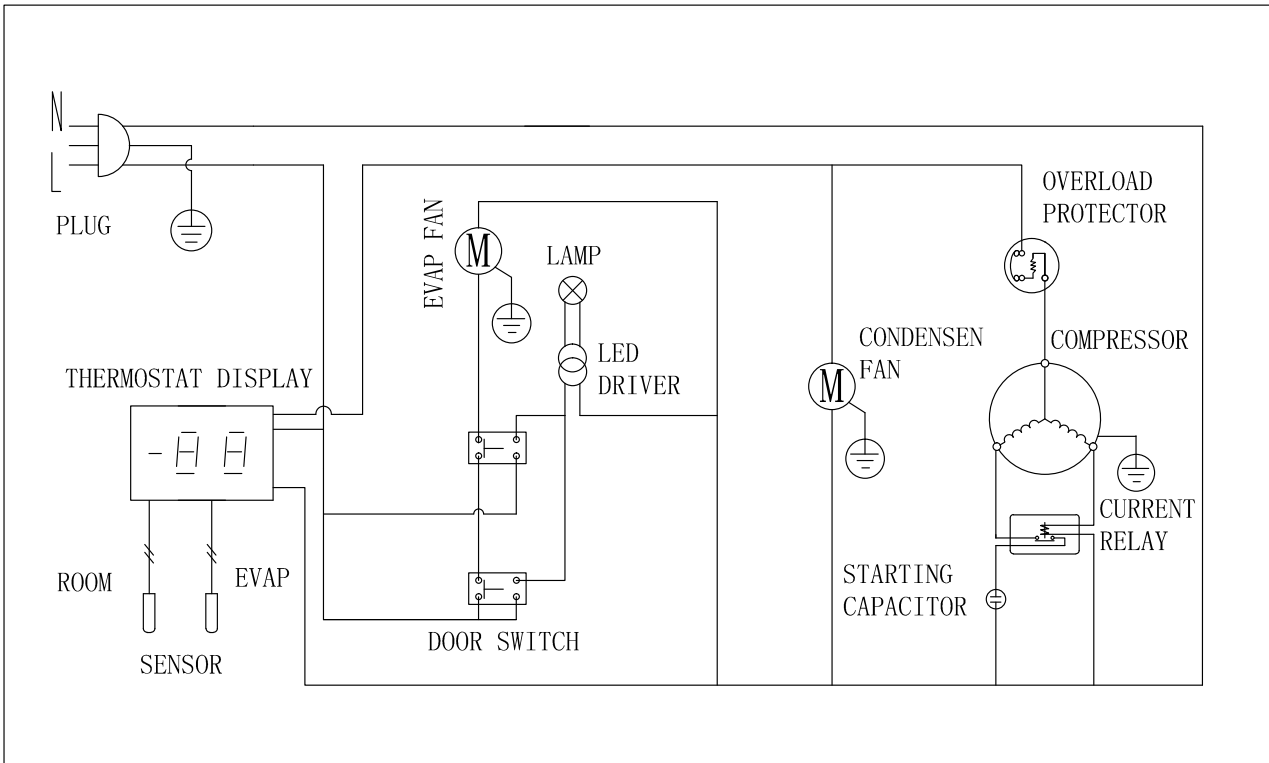

MODEL:BB-3D-90/BB-3D-90-SI

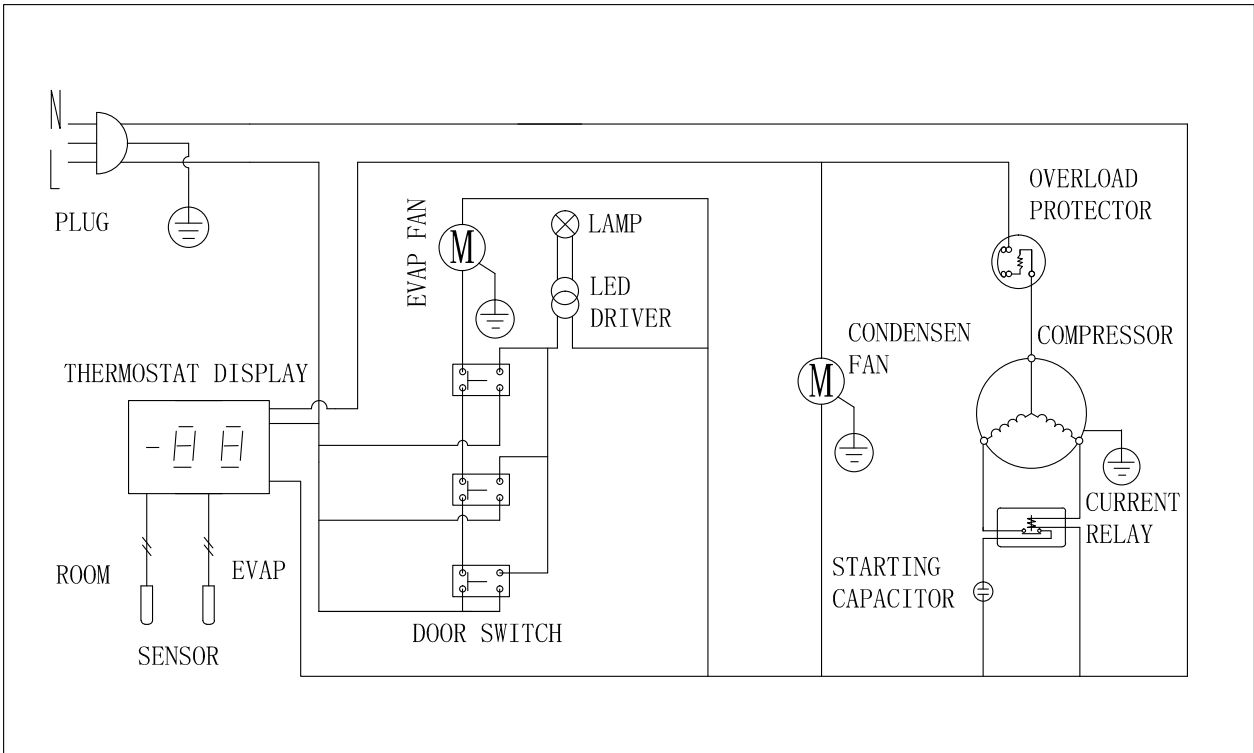

# CIRCUIT DIAGRAM

MODEL:BB-2D-60-G/BB-2D-70-G/BB-2D-60-G-SI/BB-2D-70-G-SI

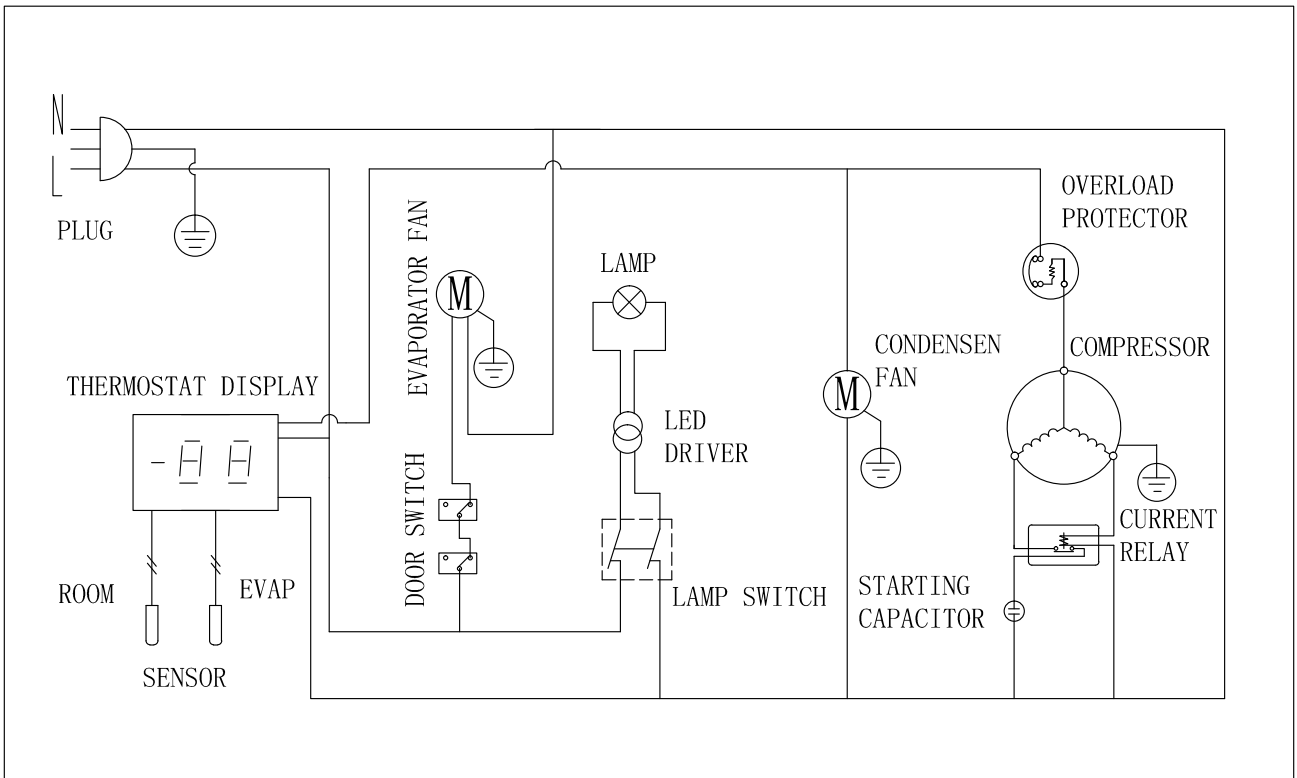

MODEL:BB-3D-90-G/BB-3D-90-G-SI

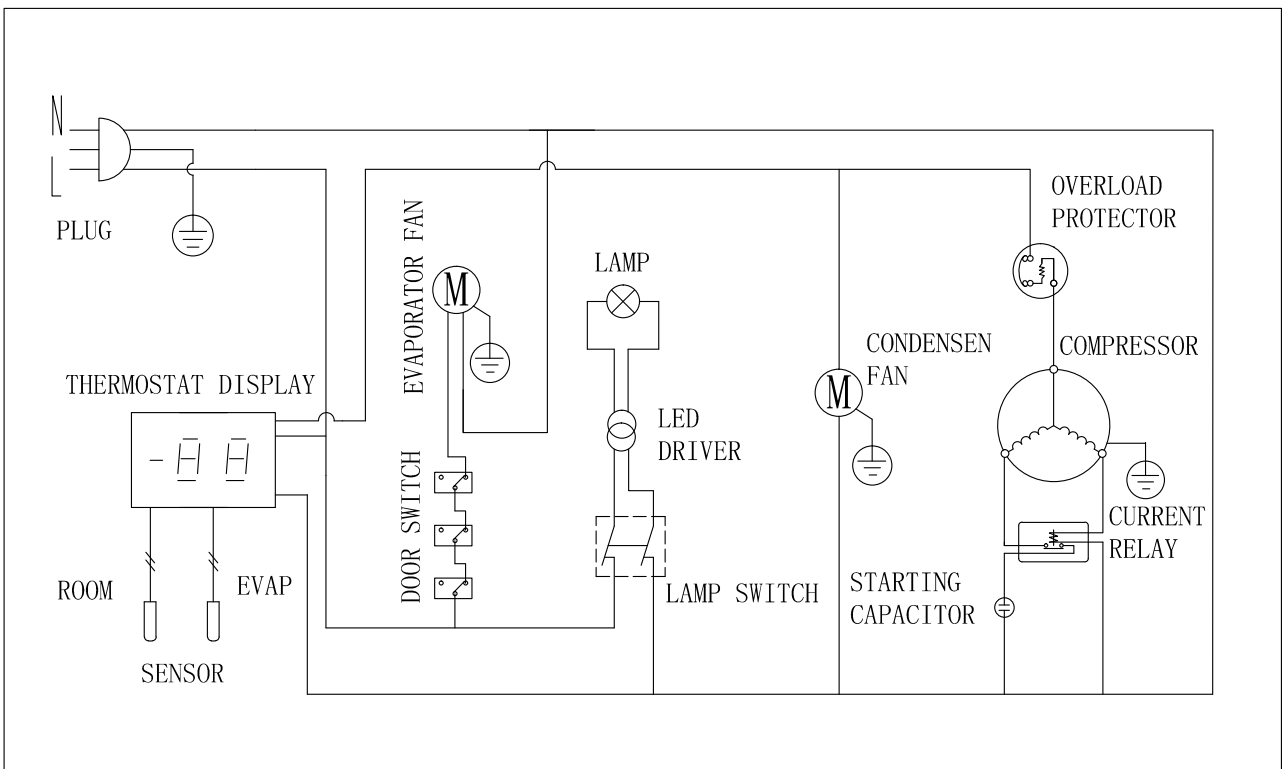



## STANDARD TWO-YEAR WARRANTY

**(TWO-YEAR PARTS & LABOR WARRANTY For products produced after serial number 1301ENTH00001.)**

ENTRÉE L.L.C. warrants to the original purchaser of every new refrigerated unit, the cabinet and all parts thereof, to be free from defects in material or workmanship, under normal and proper use and maintenance service as specified by ENTRÉE LLC and upon proper installation in accordance with the Owner's Manual supplied with each Entrée L.L.C. unit. Entrée L.L.C. obligation under this warranty is limited to a period of two (2) years from the date of original purchase or thirty 30 months after shipment date from Entree, whichever occurs first. Any model of refrigeration equipment installed in a non-permanent structure, such as a mobile kitchen and/or trailer shall have a thirty (30) days limited warranty from the date of purchase. Proof of purchase required.

Any part covered under this warranty that is determined by Entrée to have been defective within two (2) years of original purchase or thirty (30) months after shipment date from manufacturer, whichever occurs first, is limited to the repair or replacement, including labor charges, of defective parts or assemblies. The labor warranty shall include standard straight time labor charges only and the established flat rate trip charges.

Warranty does not cover standard wear parts which include door gaskets, incandescent bulbs or fluorescent bulbs, loosened fasteners of door or lid hinges. Warranty also does not cover issues caused by improper installation or lack of basic preventative maintenance which includes regular cleaning of condenser coils.

### ADDITIONAL THREE-YEAR COMPRESSOR WARRANTY

In addition to the Two (2) year warranty stated above, Entrée L.L.C. warrants its hermetically sealed compressor to be free from defects in both material and workmanship under normal and proper use and maintenance service for a period of three (3) additional years from the date of original installation but not to exceed five (5) years and three (3) months after shipment from the manufacturer. Removal or defacement of the original Serial Number or Model Number from any Unit shall be deemed to release Entree from all obligations hereunder or any other obligations, express or implied.

IF THE CUSTOMER IS USING A PART THAT RESULTS IN A VOIDED WARRANTY AND AN ENTREE AUTHORIZED REPRESENTATIVE TRAVELS TO THE INSTALLATION ADDRESS TO PERFORM WARRANTY SERVICE, THE SERVICE REPRESENTATIVE WILL ADVISE CUSTOMER THE WARRANTY IS VOID. SUCH SERVICE CALLS WILL BE BILLED TO CUSTOMER AT THE AUTHORIZED SERVICECENTER'S THEN APPLICABLE TIME AND MATERIALS RATES.

If shipment of a replacement part is requested by the end user prior to the arrival in the Entree factory of the part claimed to be defective, the Original Purchaser must accept delivery of the replacement part of a C.O.D. basis, with credit being issued after the part has been received and inspected at Entree's plant and determined by Entree to be within this warranty.

Compressors determined by Entrée L.L.C. to have been defective within this extended time period will, at Entrée L.L.C. option, be either repaired or replaced with a compressor or compressor parts of similar design and capacity. The freight charges for sending a replacement compressor are not covered by this warranty. Replacement of a defective Compressor is limited to one (1) Compressor by us during the three years period.

The three (3) year extended compressor warranty applies only to hermetically sealed parts of the compressor and does not apply to any other parts or components, including, but not limited to: cabinet, paint finish, temperature control, refrigerant, metering device, driers, motor starting equipment, fan assembly or any other electrical component, etcetera.





## STANDARD TWO-YEAR WARRANTY

(TWO-YEAR PARTS & LABOR WARRANTY For products produced after serial number 1301ENTH00001.)

### 404A/134A COMPRESSOR WARRANTY

The compressor warranty detailed above will be voided if the following procedure is not carefully adhered to:

1. If the refrigerator/freezer does not cool within 1 hour/60 minutes, turn the unit off and call for service. If the refrigeration system is void of Freon and the compressor is allowed to run more than an hour damage will occur to the compressor and will cause it to fail. Failure/replacement of the compressor in this manner is not covered by this warranty.
2. Drier replacement is very important and must be changed when a system is opened for servicing. The new drier must also be the same capacity as the drier being replaced.
3. Micron level vacuums must be achieved to insure low moisture levels in the system. 500 microns or lower must be obtained.

### WARRANTY CLAIMS

All requests for must be called into 1-704-900-2068 to obtain and agree to service dispatch with Warranty Claim Payment Terms. All claims for labor or parts must be made directly through Entrée L.L.C.

All claims should include: Dispatch number, model number of the unit, the serial number of the cabinet, proof of purchase, date of installation, and all pertinent information supporting the existence of the alleged defect.

In case of warranty compressor, the compressor warranty form must be filled out by a qualified refrigeration technician. This form can be obtain by down load from our website: [www.entree.biz](http://www.entree.biz). This form must be emailed, in its completion, with a copy of the original proof of purchase to: [john@entree.biz](mailto:john@entree.biz).

### WHAT IS NOT COVERED BY THIS WARRANTY

Entrée L.L.C. sole obligation under this warranty is limited to either repair or replacement of parts, subject to the additional limitations below. This warranty neither assumes nor authorizes any person to assume obligations other than those expressly covered by this warranty. Travel beyond 50 miles round trip and more than 2 hours round trip.

**NO CONSEQUENTIAL DAMAGES. ENTRÉE L.L.C. IS NOT RESPONSIBLE FOR ECONOMIC LOSS; PROFIT LOSS; OR SPECIAL, INDIRECT, OR CONSEQUENTIAL DAMAGES, INCLUDING WITHOUT LIMITATION, LOSSES OR DAMAGES ARISING FROM FOOD OR PRODUCT SPOILAGE CLAIMS WHETHER OR NOT ON ACCOUNT OF REFRIGERATION FAILURE.**

**WARRANTY IS NOT TRANSFERABLE.** This warranty is not assignable and applies only in favor of the original purchaser/user to whom delivered. ANY SUCH ASSIGNMENT OR TRANSFER SHALL VOID THE WARRANTIES HEREIN MADE AND SHALL VOID ALL WARRANTIES, EXPRESS OR IMPLIED, INCLUDING ANY WARRANTY OF MERCHANTABILITY OR FITNESS FOR A PARTICULAR PURPOSE.

**IMPROPER USAGE.** ENTRÉE L.L.C. ASSUMES NO LIABILITY FOR PARTS OR LABOR COVERAGE FOR COMPONENT FAILURE OR OTHER DAMAGES RESULTING FROM IMPROPER USAGE OR INSTALLATION OR FAILURE TO CLEAN AND/OR MAINTAIN PRODUCT AS SET FORTH IN THE OWNER'S MANUAL PROVIDED WITH THE UNIT.

**RELOCATION OF CABINET FOR REPAIR:** Entrée L.L.C. is not responsible for the cost to move a cabinet for any reason from its position of operation on the customer's premises to make a warranty repair.





## STANDARD TWO-YEAR WARRANTY

**(TWO-YEAR PARTS & LABOR WARRANTY For products produced after serial number 1301ENTH00001.)**

RESIDENTIAL APPLICATIONS: Entrée L.L.C. assumes no liability for parts or labor coverage for component failure or other damages resulting from installation in non-commercial or residential applications.

ALTERATION, NEGLIGENCE, ABUSE, MISUSE, ACCIDENT, DAMAGE DURING TRANSIT OR INSTALLATION, FIRE, FLOOD, ACTS OF GOD. Entrée L.L.C. is

not responsible for the repair or replacement of any parts that Entrée L.L.C. determines have been subjected after the date of manufacture to alteration, neglect, abuse, misuse, accident, damage during transit or installation, fire, flood, or act of God.

IMPROPER ELECTRICAL CONNECTIONS. ENTRÉE L.L.C. IS NOT RESPONSIBLE FOR THE REPAIR OR REPLACEMENT OF FAILED OR DAMAGED COMPONENTS RESULTING FROM INCORRECT SUPPLY VOLTAGE, THE USE OF EXTENSION CORDS, LOW VOLTAGE, OR UNSTABLE SUPPLY VOLTAGE. THE USE OF PIERCING VALVES IS PROHIBITED AND IF LEFT IN THE SYSTEM VOIDS ALL WARRANTIES. THIS EQUIPMENT IS INTENDED FOR INDOOR USE ONLY.

NO IMPLIED WARRANTY OF MERCHANTABILITY OR FITNESS FOR A PARTICULAR PURPOSE: THERE ARE NO OTHER WARRANTIES, EXPRESSED, IMPLIED OR STATUTORY, EXCEPT THE TWO (2) YEAR PARTS & LABOR WARRANTY AND THE ADDITIONAL THREE (3) YEAR COMPRESSOR WARRANTY AS DESCRIBED ABOVE. THESE WARRANTIES ARE EXCLUSIVE AND IN LIEU OF ALL OTHER WARRANTIES, INCLUDING IMPLIED WARRANTY AND MERCHANTABILITY OR FITNESS FOR A PARTICULAR PURPOSE. THERE ARE NO WARRANTIES WHICH EXTEND BEYOND THE DESCRIPTION ON THE FACE HEREOF.

OUTSIDE U.S.: This warranty does not apply to, and Entrée L.L.C. is not responsible for, any warranty claims made on products sold or used outside the United States and Canada.





***ENTRÉE LLC***

***4673 OSBORNE DRIVE SUITE D***

***EL PASO, TX 79922***

***Warranty Service- Technical Support***

***(704) 900 2068***