



PART LIST FOR CHEF BASE MODELS:

ECB36X, ECB48X, ECB52X, ECB52-60TX,
ECB60X, ECB72X, AND ECB84X



For Parts Call 704-900-2068, Option #2

Revision Date: 02/28/24

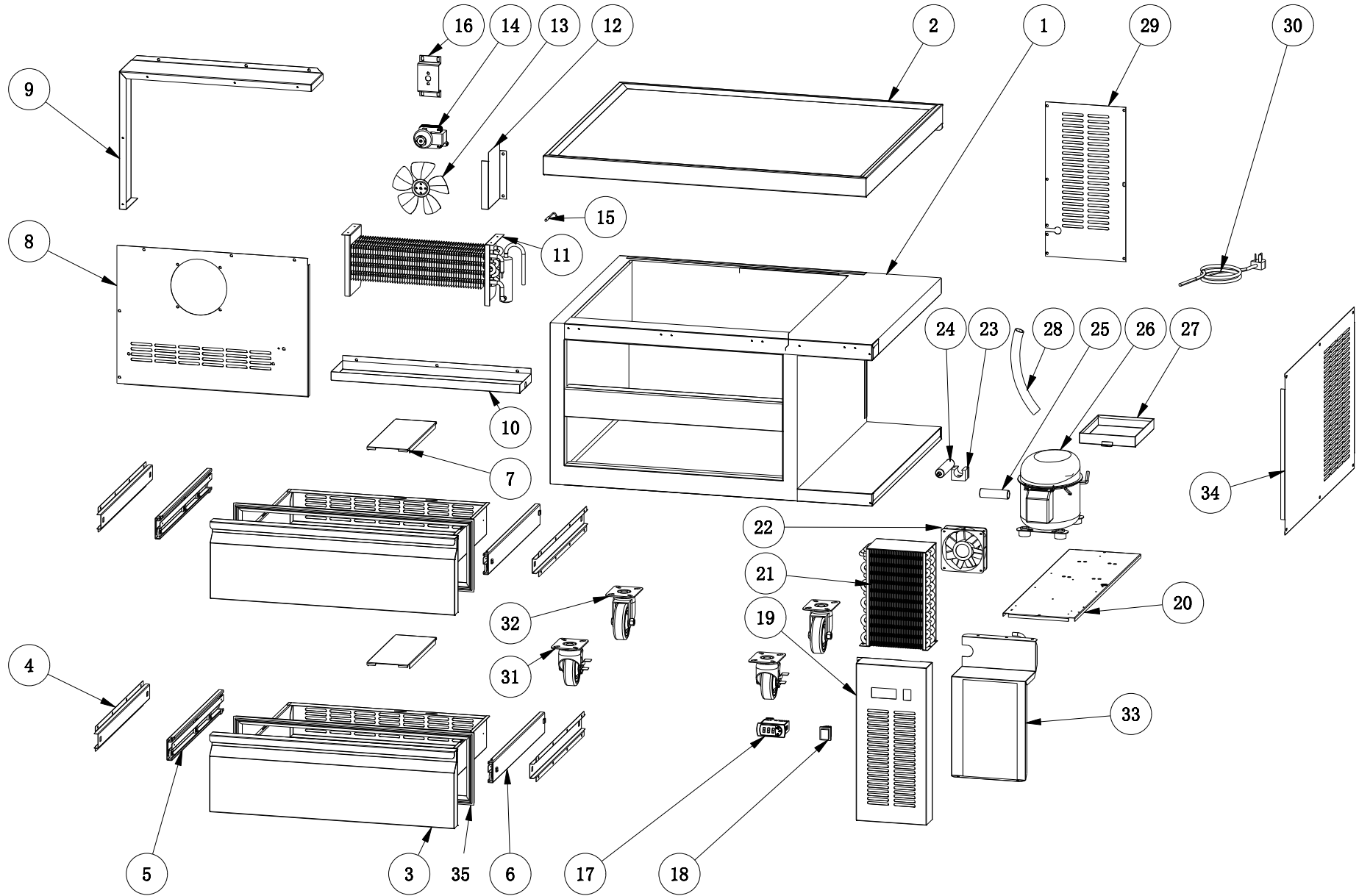

MODEL ECB36X

MODEL ECB36X

NO.	PART #	DESCRIPTION	QTY
1	N/A	CABINET	1
2	N/A	TOP BOARD	1
3	XRD001036	DRAWER	2
4	X2199001707	HANGING SHEET FOR DRAWER	4
5	X2199001708	DRAWER LEFT SLIDE	2
6	X2199001709	DRAWER RIGHT SLIDE	2
7	XRD003600	PAN BRACKET	2
8	XRD003606	EVAPORATOR COVER	1
9	N/A	EVAPORATOR COVER PLATE	1
10	XRD003608	INNER DRAIN PAN	1
11	XX-EVP110	EVAPORATOR	1
12	N/A	AIR GUIDE SHEET	1
13	X16381737612	BLADE OF EVAPORATOR FAN MOTOR	1
14	X22752520015	EVAPORATOR FAN MOTOR	1
14	XRI000035	EVAPORATOR FAN MOTOR (REPLACES X22752520015 07/22)	1
15	XRI0039	TEMPERATURE SENSOR (NTC TYPE, 118" BLUE)	1
16	X2199001715	EVAPORATOR FAN MOTOR MOUNTING BRACKET	1
17	XRI0060	THERMOSTAT (XR03CX-4N0F1/115V)	1
18	XRI0056	POWER SWITCH	1
19	X2199001716	CONTROL PANEL	1
20	N/A	COMPRESSOR UNIT INSTALLATION BOARD	1
21	X17303080110	CONDENSER	1
21	X2400200488	CONDENSER COIL (5R14K150L) REPLACES X17303080110 07/22	1
22	X1003001114715	CONDENSER FAN MOTOR (REPLACED 09/19 WITH XRD00100)	1
22	XRD00100	FAN MOTOR (BOX TYPE) (REPLACED WITH XRD100101 JUNE 2022)	1
22	XRD00101	FAN MOTOR (12038B1HL) REPLACES XRD100100 JUNE 2022	1
23	XX-H00345	FILTER DRIER MOUNTING BRACKET	1
24	XX-H00341	FILTER DRIER (D25X167-D)	1
25	XSTARTKIT02	START KIT (EM2X3113U)	1
26	X17202163113	COMPRESSOR (EM2X3113U/115V/60HZ/R290)	1
27	X16316130005	CONDENSER DRAIN PAN	1
28	XX-DT0135	DRAIN HOSE	1
29	X2199001718	BACK GRILL	1
30	XX-2194684	POWER CORD (NEMA 5-15P, 16AWG, 8')	1
31	X12533110012	4" CASTOR WITH BRAKE	2
32	X12533110013	4" CASTOR	2
33	N/A	CONDENSER AIR GUIDE SHEET	1
34	X2199001720	AIR DUCT	1
35	XRD002675	GASKET (26.4" X 7.5")	2
36	XRD702010	PAN BRACKET (12.2" X 1.14")	4

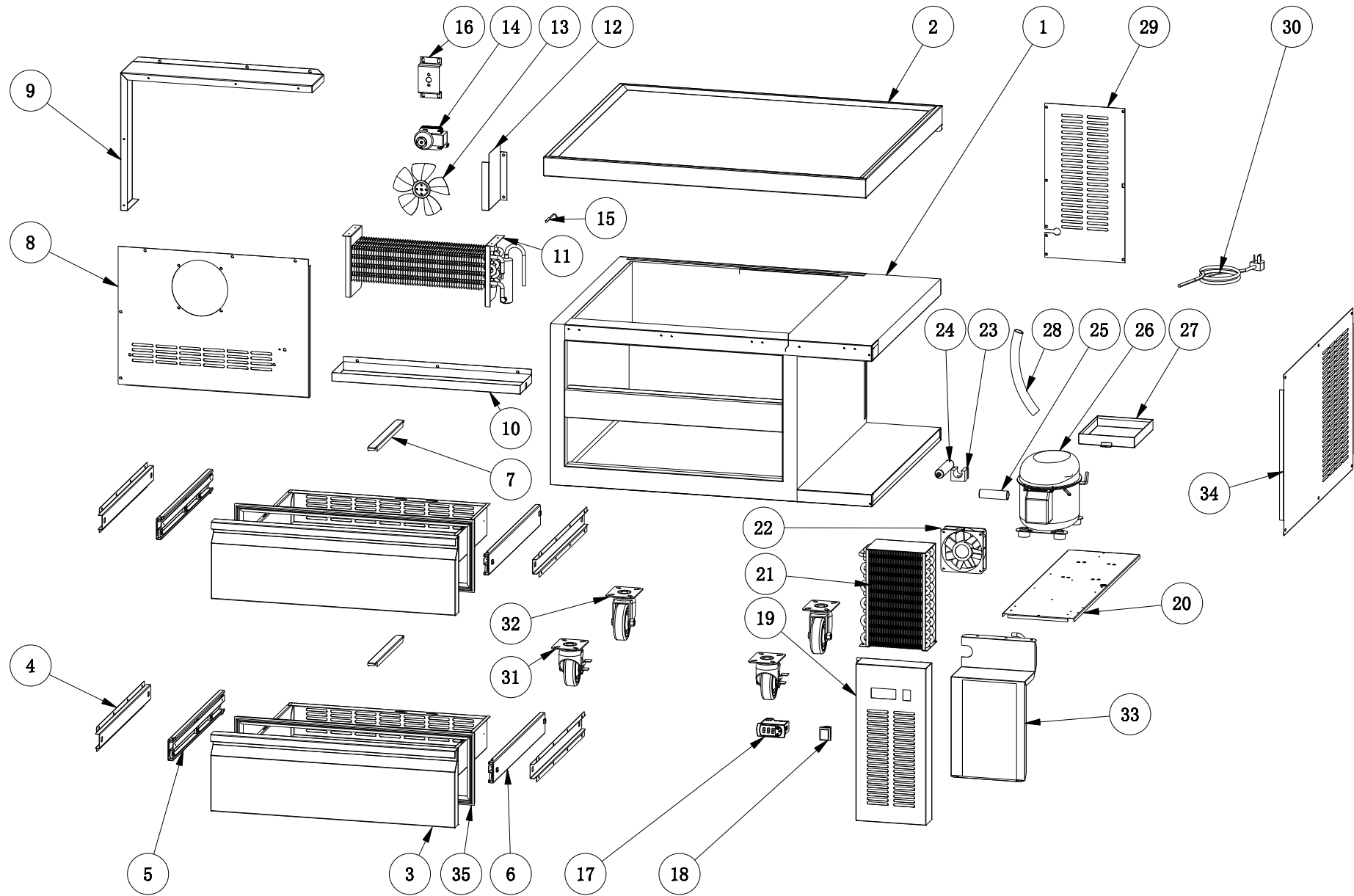

MODEL ECB48X

MODEL ECB48X

NO.	PART #	DESCRIPTION	QTY
1	N/A	CABINET	1
2	N/A	TOP BOARD	1
3	XRD001048	DRAWER	2
4	X2199001707	HANGING SHEET FOR DRAWER	4
5	X2199001708	DRAWER LEFT SLIDE	2
6	X2199001709	DRAWER RIGHT SLIDE	2
7	XRD004801	PAN BRACKET	2
8	XRD003606	EVAPORATOR COVER	1
9	N/A	EVAPORATOR COVER PLATE	1
10	XRD003608	INNER DRAIN PAN	1
11	XX-EVP110	EVAPORATOR	1
12	N/A	AIR GUIDE SHEET	1
13	X16381737612	BLADE OF EVAPORATOR FAN MOTOR	1
14	X22752520015	EVAPORATOR FAN MOTOR	1
14	XRI000035	EVAPORATOR FAN MOTOR (REPLACES X22752520015 07/22)	1
15	XRI0039	TEMPERATURE SENSOR (NTC TYPE, 118" BLUE)	1
16	X2199001715	EVAPORATOR FAN MOTOR MOUNTING BRACKET	1
17	XRI0060	THERMOSTAT (XR03CX-4N0F1/115V)	1
18	XRI0056	POWER SWITCH	1
19	X2199001716	CONTROL PANEL	1
20	N/A	COMPRESSOR UNIT INSTALLATION BOARD	1
21	X17303080110	CONDENSER	1
21	X2400200488	CONDENSER COIL (5R14K150L) REPLACES X17303080110 07/22	1
22	XRD00100	CONDENSER FAN MOTOR	1
23	XX-H00346	FILTER DRIER MOUNTING BRACKET	1
24	XX-H00344	FILTER DRIER (Φ25*145)	1
25	XSTARTKIT01	START KIT (DLE4CN)	1
26	X17202100037	COMPRESSOR (DLE4CN/115V/R290)	1
27	X16316130005	CONDENSER DRAIN PAN	1
28	XX-DT0135	DRAIN HOSE	1
29	X2199001718	BACK GRILL	1
30	XX-2194684	POWER CORD (NEMA 5-15P, 16AWG, 8')	1
31	X12533110012	4" CASTOR WITH BRAKE	2
32	X12533110013	4" CASTOR	2
33	N/A	CONDENSER AIR GUIDE SHEET	1
34	X2199001720	AIR DUCT	1
35	XRD003875	GASKET (38.4" X 7.5")	2
36	XRD002301	PAN BRACKET (21.85" X 1.14")	2
37	XRD702010	PAN BRACKET (12.2" X 1.14")	8
38	XRD002298	PAN BRACKET (21.45" X 1.14")	2
39	XRD002299	PAN BRACKET (12.85" X 1.96")	2

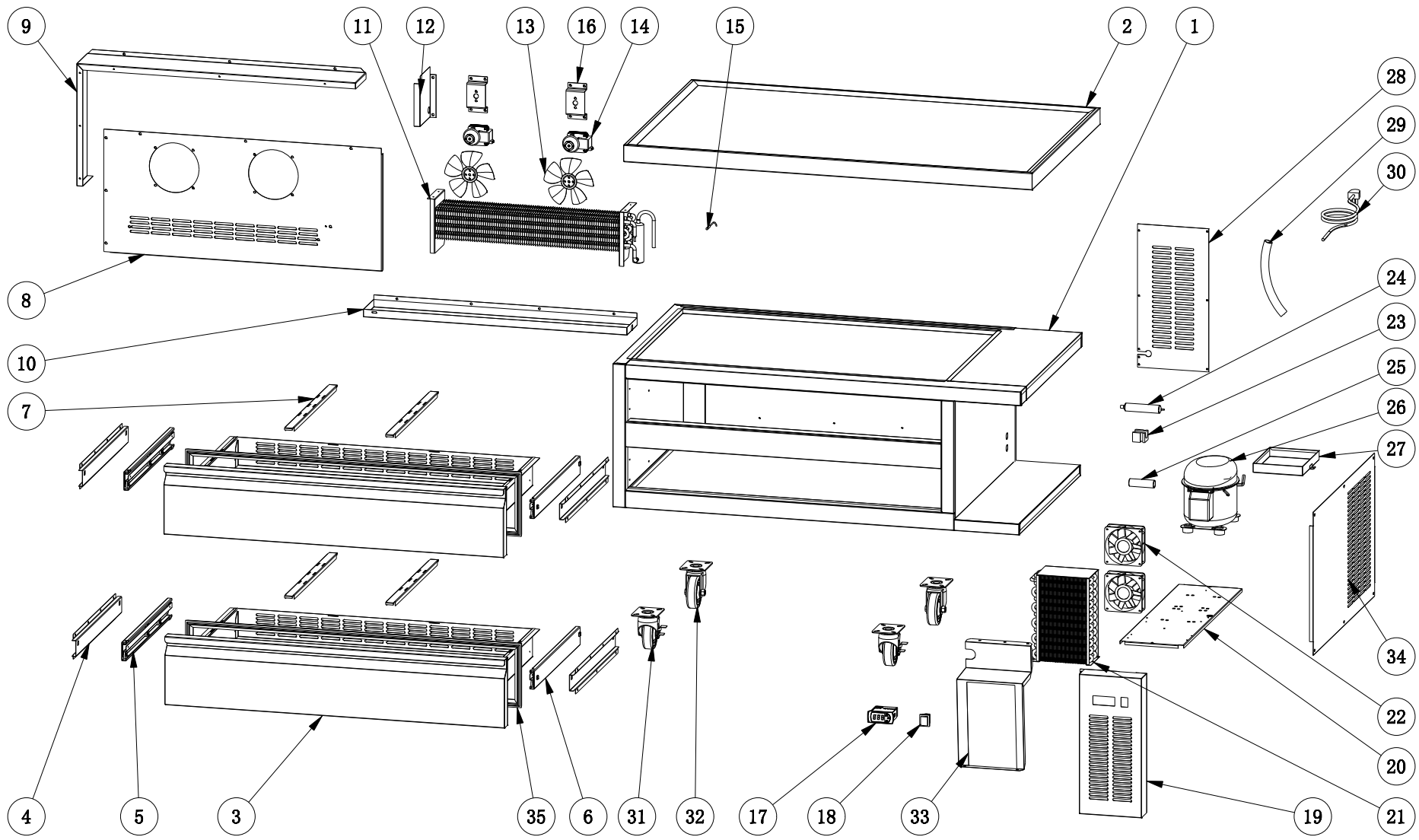

MODELS ECB52X & ECB52-60TX

MODEL ECB52X

NO.	PART #	DESCRIPTION	QTY
1	N/A	CABINET	1
2	N/A	TOP BOARD	1
3	XRD001052	DRAWER	2
4	X2199001707	HANGING SHEET FOR DRAWER	4
5	X2199001708	DRAWER LEFT SLIDE	2
6	X2199001709	DRAWER RIGHT SLIDE	2
7	XRD005200	PAN BRACKET	2
8	XRD005202	EVAPORATOR COVER	1
9	N/A	EVAPORATOR COVER PLATE	1
10	XRD005204	INNER DRAIN PAN	1
11	XX-EVP210	EVAPORATOR	1
12	N/A	AIR GUIDE SHEET	1
13	X16381737612	BLADE OF EVAPORATOR FAN MOTOR	2
14	X22752520015	EVAPORATOR FAN MOTOR	2
14	XRI000035	EVAPORATOR FAN MOTOR (REPLACES X22752520015 07/22)	2
15	XRI0039	TEMPERATURE SENSOR (NTC TYPE, 118" BLUE)	1
16	X2199001715	EVAPORATOR FAN MOTOR MOUNTING BRACKET	2
17	XRI0060	THERMOSTAT (XR03CX-4N0F1/115V)	1
18	XRI0056	POWER SWITCH	1
19	X2199001716	CONTROL PANEL	1
20	N/A	COMPRESSOR UNIT INSTALLATION BOARD	1
21	X17304110151	CONDENSER COIL (4R11K150L) REPLACED 07/22	1
21	X2400200488	CONDENSER COIL (5R14K150L) REPLACES X17304110151 07/22	1
22	X1003001114715	CONDENSER FAN MOTOR (REPLACED 09/19 WITH XRD00100)	2
22	XRD00100	FAN MOTOR (BOX TYPE) (REPLACED WITH XRD100101 JUNE 2022)	1
22	XRD00101	FAN MOTOR (12038B1HL) REPLACES XRD100100 JUNE 2022	1
23	XX-H00345	FILTER DRIER MOUNTING BRACKET	1
24	XX-H00341	FILTER DRIER (D25X167-D)	1
25	XSTARTKIT02	START KIT (EM2X3113U)	*1
26	X17202163113	COMPRESSOR (EM2X3113U/115V/60HZ/R290)	1
27	X16316130005	CONDENSER DRAIN PAN	1
28	XX-DT0135	DRAIN HOSE	1
29	X2199001718	BACK GRILL	1
30	XX-2194684	POWER CORD (NEMA 5-15P, 16AWG, 8')	1
31	X12533110012	4" CASTOR WITH BRAKE	2
32	X12533110013	4" CASTOR	2
33	N/A	CONDENSER AIR GUIDE SHEET	1
34	X2199001720	AIR DUCT	1
35	XRD004275	GASKET (42" x 7.5")	2
36	XRD702010	PAN BRACKET (12.2" X 1.14")	12

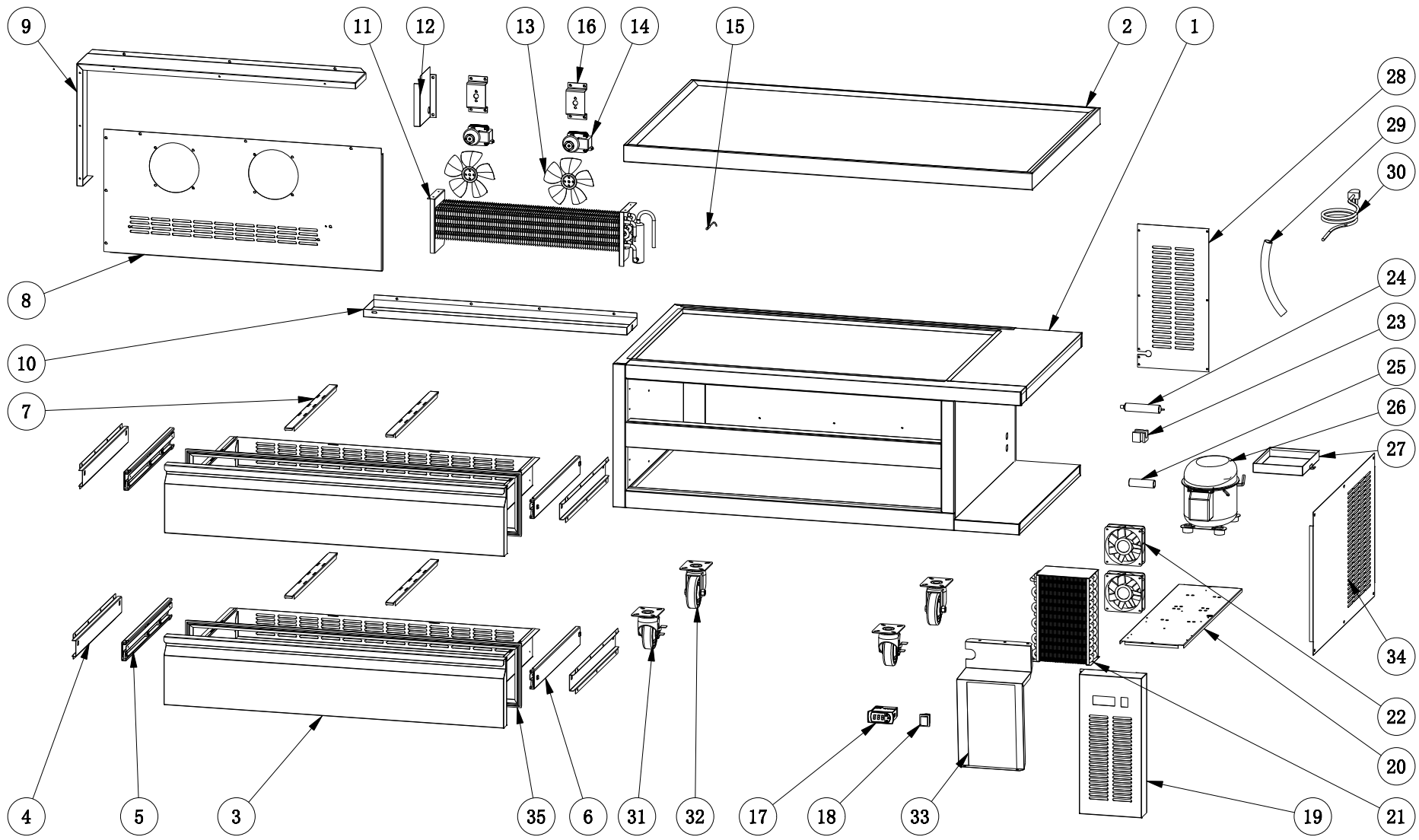

MODEL ECB60X

MODEL ECB60X

NO.	PART #	DESCRIPTION	QTY
1	N/A	CABINET	1
2	N/A	TOP BOARD	1
3	XRD001060	DRAWER	2
4	X2199001707	HANGING SHEET FOR DRAWER	4
5	X2199001708	DRAWER LEFT SLIDE	2
6	X2199001709	DRAWER RIGHT SLIDE	2
7	XRD005200	PAN BRACKET	6
8	XRD005202	EVAPORATOR COVER	1
9	N/A	EVAPORATOR COVER PLATE	1
10	XRD005204	INNER DRAIN PAN	1
11	XX-EVP210	EVAPORATOR	1
12	N/A	AIR GUIDE SHEET	1
13	X16381737612	BLADE OF EVAPORATOR FAN MOTOR	2
14	X22752520015	EVAPORATOR FAN MOTOR	2
14	XRI000035	EVAPORATOR FAN MOTOR (REPLACES X22752520015 07/22)	1
15	XRI0039	TEMPERATURE SENSOR (NTC TYPE, 118" BLUE)	1
16	X2199001715	EVAPORATOR FAN MOTOR MOUNTING BRACKET	2
17	XRI0060	THERMOSTAT (XR03CX-4N0F1/115V)	1
18	XRI0056	POWER SWITCH	1
19	X2199001716	CONTROL PANEL	1
20	N/A	COMPRESSOR UNIT INSTALLATION BOARD	1
21	X17304110151	CONDENSER COIL (4R11K150L) REPLACED 07/22	1
21	X2400200488	CONDENSER COIL (5R14K150L) REPLACES X17304110151 07/22	1
22	XRD00100	CONDENSER FAN MOTOR (REPLACED 09/19 WITH XRD00100)	2
22	XRD00101	FAN MOTOR (12038B1HL) REPLACES XRD100100 JUNE 2022	1
23	XX-H00346	FILTER DRIER MOUNTING BRACKET	1
24	XX-H00344	FILTER DRIER (Φ25*145)	1
25	XSTARTKIT01	START KIT (DLE4CN)	1
26	X17202100037	COMPRESSOR (DLE4CN/115V/R290)	1
27	X16316130005	CONDENSER DRAIN PAN	1
28	XX-DT0135	DRAIN HOSE	1
29	X2199001718	BACK GRILL	1
30	XX-2194684	POWER CORD (NEMA 5-15P, 16AWG, 8')	1
31	X12533110012	4" CASTOR WITH BRAKE	2
32	X12533110013	4" CASTOR	2
33	N/A	CONDENSER AIR GUIDE SHEET	1
34	X2199001720	AIR DUCT	1
35	XRD005075	GASKET (50.2" X 7.5")	2
35	XRD004800	PAN BRACKET (12.2" X 1.14")	12
36	XRD004803	PAN BRACKET (7" X 1.18")	4
36	XRD702009	PAN BRACKET (21.25" X 1.14")	4
36	XRD002300	PAN BRACKET (21.25" X 2.36")	2

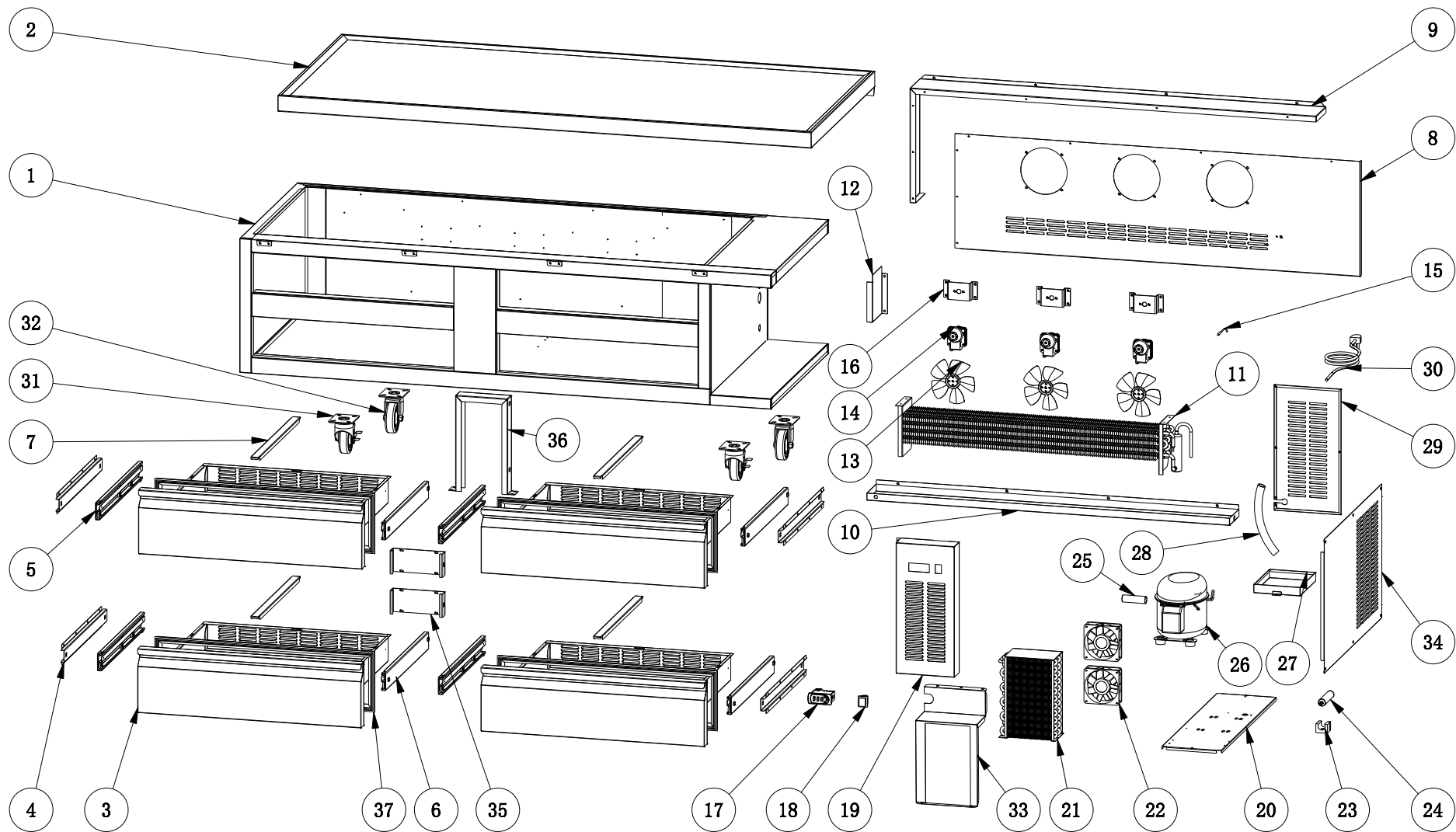

MODEL ECB72X

MODEL ECB72X

NO.	PART #	DESCRIPTION	QTY
1	N/A	CABINET	1
2	N/A	TOP BOARD	1
3	XRD001072	DRAWER	4
4	X2199001707	HANGING SHEET FOR DRAWER	8
5	X2199001708	DRAWER LEFT SLIDE	4
6	X2199001709	DRAWER RIGHT SLIDE	4
7	XRD007200	PAN BRACKET	4
8	XRD007202	EVAPORATOR COVER	1
9	N/A	EVAPORATOR COVER PLATE	1
10	XRD007204	INNER DRAIN PAN	1
11	XX-EVP610	EVAPORATOR	1
12	N/A	AIR GUIDE SHEET	1
13	X16381737612	BLADE OF EVAPORATOR FAN MOTOR	3
14	X22752520015	EVAPORATOR FAN MOTOR	3
14	XRI000035	EVAPORATOR FAN MOTOR (REPLACES X22752520015 07/22)	1
15	XRI0039	TEMPERATURE SENSOR (NTC TYPE, 118" BLUE)	1
16	X2199001715	EVAPORATOR FAN MOTOR MOUNTING BRACKET	3
17	XRI0060	THERMOSTAT (XR03CX-4N0F1/115V)	1
18	XRI0056	POWER SWITCH	1
19	X2199001716	CONTROL PANEL	1
20	N/A	COMPRESSOR UNIT INSTALLATION BOARD	1
21	X17304110151	CONDENSER COIL (4R11K150L) REPLACED 07/22	1
21	X2400200488	CONDENSER COIL (5R14K150L) REPLACES X17304110151 07/22	1
22	X1003001114715	CONDENSER FAN MOTOR (REPLACED 09/19 WITH XRD00100)	2
22	XRD00100	FAN MOTOR (BOX TYPE) (REPLACED WITH XRD100101 JUNE 2022)	1
22	XRD00101	FAN MOTOR (12038B1HL) REPLACES XRD100100 JUNE 2022	1
23	XX-H00345	FILTER DRIER MOUNTING BRACKET	1
24	XX-H00341	FILTER DRIER (D25X167-D)	1
25	XX-STARTKITHC1	START KIT (EM2X3117U/115V/60HZ/R290)	1
26	XX-HC0001	COMPRESSOR (EM2X3117U/115V/60HZ/R290)	1
27	X16316130005	CONDENSER DRAIN PAN	1
28	XX-DT0135	DRAIN HOSE	1
29	X2199001718	BACK GRILL	1
30	XX-2194684	POWER CORD (NEMA 5-15P, 16AWG, 8')	1
31	X12533110012	4" CASTOR WITH BRAKE	3
32	X12533110013	4" CASTOR	3
33	N/A	CONDENSER AIR GUIDE SHEET	1
34	X2199001720	AIR DUCT	1
35	XRD007205	SHELF RAIL OF MIDDLE BEAM	2
36	X2199001736	BACK SHELF RAIL	1
37	XRD002675	GASKET (26.4" X 7.5")	4
38	XRD702010	PAN BRACKET (12.2" X 1.14")	16

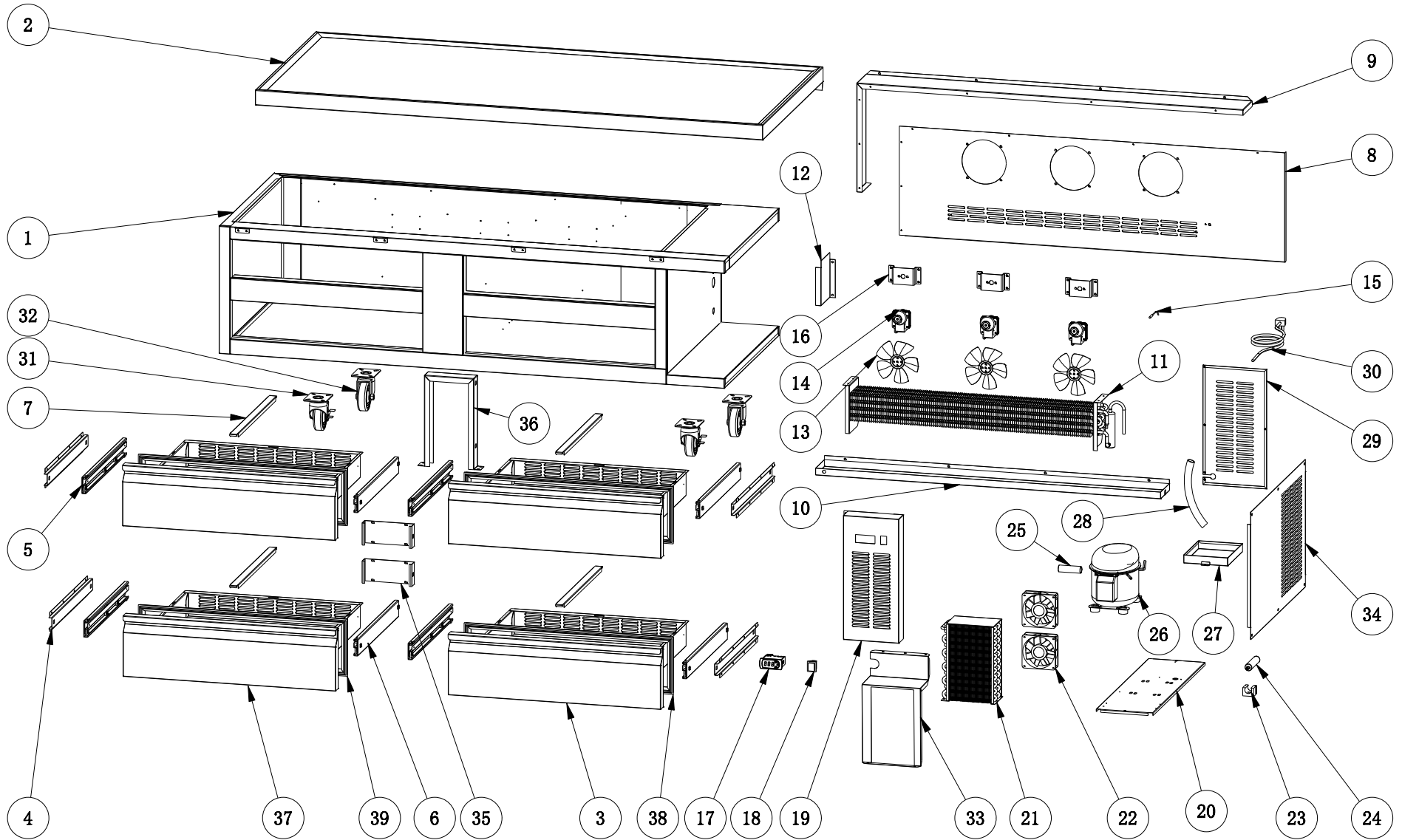

MODEL ECB84X

MODEL ECB84X

NO.	PART #	DESCRIPTION	QTY
1	N/A	CABINET	1
2	N/A	TOP BOARD	1
3	XRD001072	DRAWER	2
4	X2199001707	HANGING SHEET FOR DRAWER	8
5	X2199001708	DRAWER LEFT SLIDE	4
6	X2199001709	DRAWER RIGHT SLIDE	4
7	XRD005200	PAN BRACKET	6
8	XRD007202	EVAPORATOR COVER	1
9	N/A	EVAPORATOR COVER PLATE	1
10	XRD007204	INNER DRAIN PAN	1
11	XX-EVP610	EVAPORATOR	1
12	N/A	AIR GUIDE SHEET	1
13	X16381737612	BLADE OF EVAPORATOR FAN MOTOR	3
14	X22752520015	EVAPORATOR FAN MOTOR	3
14	XRI000035	EVAPORATOR FAN MOTOR (REPLACES X22752520015 07/22)	1
15	XRI00039	TEMPERATURE SENSOR (NTC TYPE, 118" BLUE)	1
16	X2199001715	EVAPORATOR FAN MOTOR MOUNTING BRACKET	3
17	XRI00060	THERMOSTAT (XR03CX-4N0F1/115V)	1
18	XRI00056	POWER SWITCH	1
19	X2199001716	CONTROL PANEL	1
20	N/A	COMPRESSOR UNIT INSTALLATION BOARD	1
21	X17304110151	CONDENSER COIL (4R11K150L) REPLACED 07/22	1
21	X2400200488	CONDENSER COIL (5R14K150L) REPLACES X17304110151 07/22	1
22	XRD00100	CONDENSER FAN MOTOR	2
22	XRD00101	FAN MOTOR (12038B1HL) REPLACES XRD100100 JUNE 2022	1
23	XX-H00346	FILTER DRIER MOUNTING BRACKET	1
24	XX-H00344	FILTER DRIER (Φ25*145)	1
25	XX-HC0008K	COMPRESSOR START KIT	1
26	XX-HC0008	COMPRESSOR (DLE4.8CN/115V/R290)	1
26	XX-HC0008K	START KIT FOR DLE4.8CN	*1
27	X16316130005	CONDENSER DRAIN PAN	1
28	XX-DT0135	DRAIN HOSE	1
29	X2199001718	BACK GRILL	1
30	XX-2194684	POWER CORD (NEMA 5-15P, 16AWG, 8')	1
31	X12533110012	4" CASTOR WITH BRAKE	3
32	X12533110013	4" CASTOR	3
33	N/A	CONDENSER AIR GUIDE SHEET	1
34	X2199001720	AIR DUCT	1
35	XRD008405	SHELF RAIL OF MIDDLE BEAM	2
36	X2199001953	BACK SHELF RAIL	1
37	XRD001052	DRAWER	2
38	XRD002675	GASKET (26.4" X 7.5")	2
39	XRD004275	GASKET (42" x 7.5")	2
40	N/A	CONNECTOR	
41	XRD702010	PAN BRACKET (12.2" X 1.14")	10



PART LIST FOR CHEF BASE MODELS:

ECB36X, ECB48X, ECB52X, ECB52-60TX,
ECB60X, ECB72X, AND ECB84X



For Parts Call 704-900-2068, Option #2