



Owner's Manual – Installation Guide



Model F3
(3 Burner Fryer)



Model F4
(4 Burner Fryer)



Model F5
(5 Burner Fryer)

⚠ WARNING

Improper installation, adjustment, alteration, service or maintenance can cause property damage, injury or death. Read the installation, operating and maintenance instructions thoroughly before installing or servicing this equipment.

If installing the fryer with Propane (LP) gas a Commercially Approved "STAGE REGULATOR" OR "TANK REGULATOR" MUST be installed the LPG tank.

Units installed without a proper stage regulator will cause damage to parts and will void the warranty.

To insure proper warranty record your information here:

For Warranty Service Call (704)-900-2068

Revision 20230814

Page 1

Date of Purchase: _____

Dealer Purchase from: _____

Name of Installer: _____ Phone Number: _____

Model Number: _____

Serial Number: _____

**Warranty Service– Technical Support
(704) 900 2068**



BE SURE TO HAVE MODEL NUMBER AND SERIAL NUMBER AVAILABLE WHEN CALLING FOR SERVICE OR PARTS.

Attached a copy for your proof of purchase here.

SAFETY PRECAUTIONS

Before installing and operating this equipment, be sure everyone involved in its operation is fully trained and aware of precautions. Accidents and problems can be caused by failure to follow fundamental rules and precautions.

The following symbols, found throughout this manual, alert you to potentially dangerous conditions to the operator, service personnel, or to the equipment.

 DANGER	This symbol warn of immediate hazards that will result in severe injury or death.
 WARNING	This symbol refers to a potential hazard or unsafe practice that could result in injury or death.
 CAUTION	This symbol refers to a potential hazard or unsafe practice that could result in injury, product damage, or property damage.
NOTICE	This symbol refers to information that needs special attention or must be fully understood, even though not dangerous.

 WARNING

FIRE HAZART FOR YOUR SAFETY

Do not store or use gasoline or other flammable vapors and liquids in the vicinity of this or any other appliance.

Keep area around appliances free and clear of combustibles.

Purchaser of equipment must post in a prominent location, detailed instructions to be followed in the event the operator smells gas.

Obtain the instructions from the local gas supplier.

 WARNING

BURN HAZARD

Contact with hot oil will cause severe burns. Always use caution. Oil at 200°F is more dangerous than boiling water.

 WARNING

In the event a gas odor is detected, shut down equipment at the combination gas valve and contact local gas company or gas supplier.

NOTICE

Entrée Gas Floor Model Fryers are intended for commercial use only. Not for household or residential use.

Warranty will be void if service work is performed by other than a qualified technician, or if other than Non genuine Entrée replacement parts are installed.

Be sure this Operator's Installer's Manual and important papers are given to the proper authority to retain for future reference.

Congratulations! You have purchased one of the finest pieces of commercial cooking equipment on the market.

You will find that your new equipment, like all Entree equipment, has been designed and manufactured to meet the toughest standards in the industry. Each piece of Entree equipment is carefully engineered and designs are verified through laboratory tests and field installations. With proper care and field maintenance, you will experience years of reliable, trouble-free operation. For best results, read this manual carefully.

RETAIN THIS MANUAL FOR FUTURE REFERENCE.

MODELS

This manual is for Entrée Gas Floor Model Fryers with 35 pound (F3), 55 pound (F4), and 85 pound (F5) capacities. The capacity is described on the serial plate that is located on the inside of the front door.

TABLE OF CONTENTS

Specifications	Page 5
Installation	Page 6
Operation	Page 12
Cooking Hints	Page 14
Cleaning.....	Page 14
Parts.....	Page 16

Read these instructions carefully before attempting installation. Installation and initial startup should be performed by a qualified installer. Unless the installation instructions for this product are followed by a qualified service technician (a person experienced in and knowledgeable with the installation of commercial gas and/or electric cooking equipment) then the terms and conditions on the Manufacturer's Limited Warranty will be rendered void and no warranty of any kind shall apply.

SPECIFICATION

Dimensions

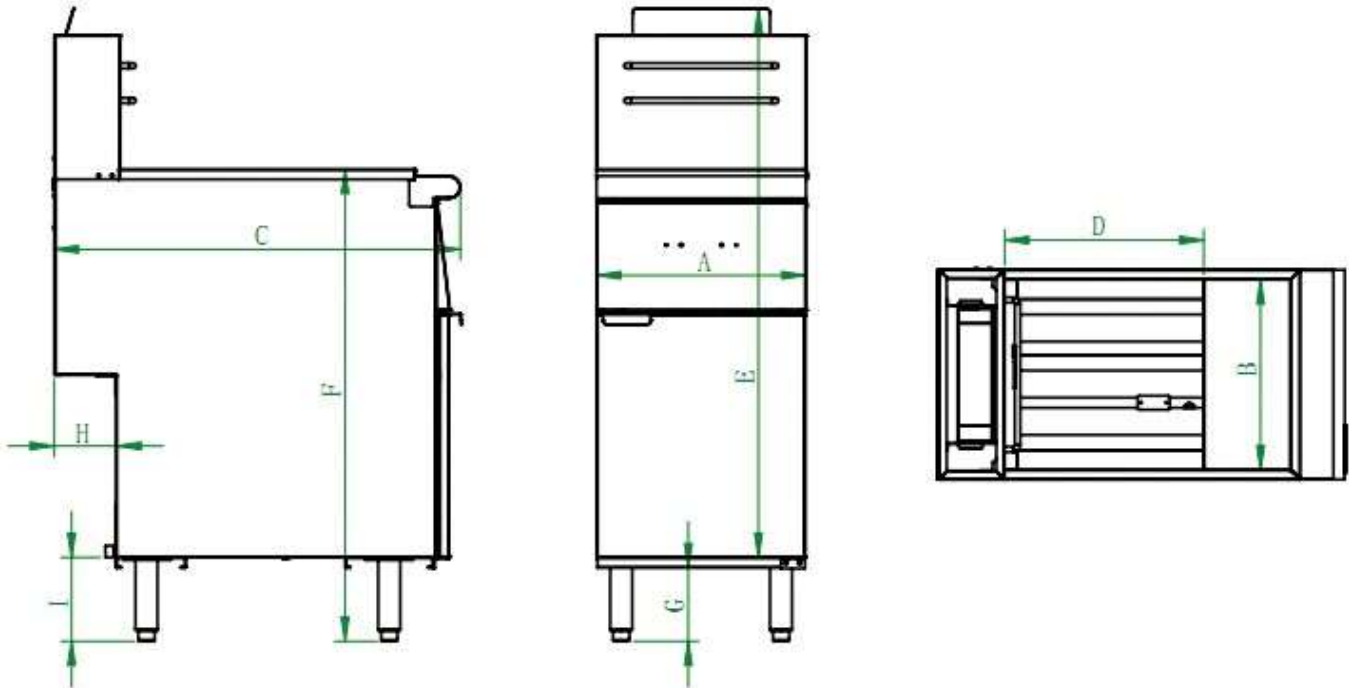

Model	Width (in)		Depth (in)		Height (in)			Gas Connection (in)		Total BTU/Hr	Crated Weight (lbs.)
	A	B	C	D	E	F	G	H	I		
F3	15.5"	14.0"	30.3"	14.0"	47.2"	34.7"	6.0"	4.2"	7.0"	90,000	169
F4	15.5"	14.0"	30.3"	14.0"	47.2"	34.7"	6.0"	4.2"	7.0"	120,000	183
F5	21.0"	18.0"	34.3"	18.0"	47.2"	34.7"	6.0"	4.2"	7.0"	150,000	209

GAS SUPPLY AND BURNER INFORMATION

Supply pressure should be a minimum of 6" W.C. for Natural Gas and 12" W/C. for propane. The fryer comes with 3/4" NPT male connector on a 1/2" pipe, allowing you to connect with either a 3/4" or 1/2" NPT female connector.

Model	Gas Type	Manifold Pressure	Number of heat tubes	BTU Rate per Burner	Total BTU Rating	Orifice Size
F3-N	NATURAL	4" W.C.	3	30,000	90,000	#39
F3-P	PROPANE	10" W.C.	3	30,000	90,000	#52
F4-N	NATURAL	4" W.C.	4	30,000	120,000	#39
F4-P	PROPANE	10" W.C.	4	30,000	120,000	#52
F5-N	NATURAL	4" W.C.	5	30,000	150,000	#39
F5-P	PROPANE	10" W.C.	5	30,000	150,000	#52

Minimum supply pressure is 6" W.C. for natural gas and 12" W.C. for propane.
Orifice sizes are for units installed at altitudes between 0 and 2000 feet above sea level.

Installation

NOTICE

Installation must conform with local codes, or in the absence of local codes, with the National Fuel Gas Code, ANSI Z223.1, Natural Gas Installation Code, CAN/CGA-B149.1, or the Propane Installation Code, CAN/CGA-B149.2, as applicable.

NOTICE

These installation procedures must be followed by qualified personnel or warranty will be void. Local codes regarding installation vary greatly from one area to another. The National Fire Protection Association, Inc. states in its NFPA 96 latest edition that local codes are the “authority having jurisdiction” when it comes to installation requirements for equipment.

Step #1: Unpack

****IMMEDIATELY INSPECT FOR SHIPPING DAMAGE**

All containers should be examined for damage before and during unloading. The freight carrier has assumed responsibility for safe transit and delivery. If damaged equipment is received, either apparent or concealed, a claim must be made with the delivering carrier.

Apparent damage or loss must be noted on the freight bill at the time of delivery. The freight bill must then be signed by the carrier representative (Driver). If the bill is not signed, the carrier may refuse the claim. The carrier can supply the necessary forms.

A request for inspection must be made to the carrier within 15 days if there is concealed damage or loss that is not apparent until after the equipment is uncrated. The carrier should arrange an inspection.

Be certain to hold all contents plus all packing material.

1. Uncrate carefully. Report any hidden damage to the freight carrier IMMEDIATELY.
2. Do not remove any tags or labels until unit is installed and working properly.

****CAUTION****

The stage or tank regulator must be set to gas pressure between 11” W.C. and 12” W.C.
Note: There is a pressure regulator “built in” to the combination gas valve, if the incoming pressure is at 10” W.C. or lower this “built in” regulator will act as a restriction and cause incomplete combustion and sooting. If the gas pressure is above 12” W.C. damage could occur to the “built in” pressure regulator and in that case, it would have to be replaced, this would not be covered by the warranty.

Step #2: Install the Legs (or Casters) and Restraints

A set of legs or casters is packed with the fryer. Mounting fasteners are pre-mounted on the base plates.

1. Raise fryer sufficiently to allow legs or casters to be screwed into the base plate. For safety, “shore up” and support the fryer with an adequate blocking arrangement strong enough to support the load.
2. Screw the four legs or casters to the plate on the bottom of the fryer. When casters have been ordered, the casters having a locking-brake should be attached under the front of the fryer.
3. Lower the fryer gently. Never drop or allow the fryer to fall.
4. Use a level to make sure that the fryer is level. Each caster, or the tubular-end of each leg, can be screwed in or out to lower or raise each corner of the fryer.
5. Attach restraints as required by local codes.

***NOTICE***

Unit must be level to assure maximum performance and proper ventilation. Improper leveling may void warranty.

NOTICE

When this appliance is installed with casters, it must be installed with the casters supplied, a connector complying with either ANSI Z21.69 CSA 6.16 and a quick-disconnect device complying with ANSI Z21.41 CSA 6.9. It must also be installed with restraining means to guard against transmission of strain to the connector, as specified in the appliance manufacturer instructions.

⚠ WARNING

When this appliance is installed with casters, it must be installed with the casters supplied, a connector complying with either ANSI Z21.69 or CAN/CGA-6.16 and a quick disconnect device complying with either ANSI Z21.41 or CAN1-6.9. It must also be installed with restraining means to guard against transmission of strain to the connector, as specified in the appliance manufacturer's instructions.

⚠ WARNING

All fryers must be restrained to prevent tipping in order to avoid the splashing of hot liquid. The means of restraint may be the manner of installation.

Step #3: Flue Installation

1. Unpack the flue box and flue wrap



2. Slide the flue box over the flue and secure it with the two self-tapping screws using a 5/16" socket



3. Slide the flue wrap over the flue.

4. Secure it with four self-tapping screws, two on the back and one on each side using a 5/16" socket.



Step #4: Check Clearances and Ventilation

Select a firm, level location for your fryer. Leave clearance, whenever possible, so that access from the rear is possible to permit cleaning. If the unit is to be set on non-combustible flooring, such as a concrete slab, 3 inches minimum toe room must be provided to prevent restriction of the air opening in the bottom of the unit.

⚠ WARNING

There must be adequate clearance between fryer(s) and construction. Clearance must also be provided in front for servicing and for operation.

Minimum Clearances from Combustible Construction:

Sides:	Six (6) Inches
Rear:	Six (6) Inches

ALL ENTRÉE FRYERS SHALL BE INSTALLED WITH AT LEAST A 16 INCH SPACE BETWEEN THE FRYER AND SURFACE FLAMES FROM ADJACENT EQUIPMENT. A FLAME GUARD IS ACCEPTABLE IF ALLOWED UNDER LOCAL CODE.

“SUITABEL FOR INSTALLATION ON COMBUSTIBLE FLOORS”

No additional side and rear clearance is required for service as the fryer is serviceable from the front.

⚠ WARNING

Improper ventilation can result in personal injury or death. Ventilation that fails to properly remove flue products can cause headaches, drowsiness, nausea, or could result in death.

Unit Must be installed under a ventilation hood.

All units must be installed in such a manner that the flow of combustion and ventilation air is not obstructed. Provisions for adequate air supply must also be provided. Do NOT obstruct the bottom front of the unit, as combustion air enters through this area. Be sure to inspect and clean the ventilation system according to the ventilation equipment manufacturer's instructions.

Due to the variety of problems that can be caused by outside weather conditions, venting by canopies or wall fans is preferred over any type of direct venting. It is recommended that a canopy extend 6" past the appliance and the bottom edge be located 6"6" from the floor. Filters should be installed at an angle of 45° or more from the horizontal. This position prevents dripping of grease and facilitates collecting the run-off grease in a drip pan, unusually installed with a filter. A strong exhaust fan tends to create a vacuum in the room and may interfere with burner performance or may extinguish pilot flames. Fresh air openings approximately equal to the fan area will relieve such a vacuum. In case of unsatisfactory performance on any appliance, check the appliance with the exhaust fan in the "OFF" position. Do this only long enough to check equipment performance, then turn hood back on and let it run to remove any exhaust that may have accumulated during the test.

The exhaust fan should be installed at least 2 feet above the vent opening at the top of the fryer. Make sure all ventilation meet local code requirement

This unit is not intended to be connected directly to an outside flue.

Step #5: Gas Connection

A 3/4" male NPT line for the gas connection is located near the lower right rear corner of the fryer. The serial plate (located inside the front door of the fryer) indicates the type of gas the unit is equipped to burn (natural gas or propane). The fryer should be connected **ONLY** to the type of gas for which it is equipped.

A circuit diagram is located inside the front door of the fryer.

All Entree equipment is adjusted at the factory; however, pilot height should be checked at installation and adjusted, if necessary.

For orifice sizes and pressure regulator settings, see the chart on page 4. If the fryer is being installed at over 2,000 feet altitude and that information was not specified when ordered, contact the appropriate authorized Entree Service Representative or the Entree Service Department. Failure to install with proper orifice sizing will result in poor performance and may void the warranty.

If applicable, the vent line from the gas appliance pressure regulator shall be installed to the outdoors in accordance with local codes or, in the absence of local codes, with the National Fuel Gas Code, ANSI Z223.1, Natural Gas Installation Code, CAN/CGA-B149.1, or the Propane Installation Code, CAN/CGA-B149.2, as applicable.

An adequate gas supply is imperative. Undersized or low pressure lines will restrict the volume of gas necessary for satisfactory performance. A combination gas valve and pressure regulator, which is provided with each unit, is set to maintain a 4" W.C. manifold pressure for natural gas or 10.0" W.C. manifold pressure for propane gas. However, to maintain these conditions the pressure on the supply line, when all units are operating simultaneously, should not drop below 7" W.C. for natural gas or 11" W.C. for propane gas. Fluctuations of more than 25% on natural gas or 10% on propane gas will create problems and affect burner operating characteristics. A 1/8" tap to measure the manifold pressure is located on the combination gas valve and on the burner manifold, which is on the burner manifold located directly below the burners inside the cabinet.

Purge the supply line to clean out dust, dirt, or other foreign matter before connecting the line to the unit.

It is recommended that an individual manual shutoff valve be installed in the gas supply line to the unit.

Use pipe joint compound that is suitable for use with both natural and LP gas on all threaded connections.

 **CAUTION**

ALL PIPE JOINTS AND CONNECTIONS MUST BE TESTED THOROUGHLY FOR GAS LEAKS. USE ONLY SOAPY WATER FOR TESTING ON ALL GASES. NEVER USE AN OPEN FLAME TO CHECK FOR GAS LEAKS. ALL CONNECTIONS MUST BE CHECKED FOR LEAKS AFTER THE UNIT HAS BEEN PUT INTO OPERATION. **TEST PRESSURE SHOULD NOT EXCEED 12" W.C.**

 **CAUTION**

THIS APPLIANCE AND ITS INDIVIDUAL COMBINATION GAS VALVE MUST BE DISCONNECTED FROM THE GAS SUPPLY PIPING SYSTEM DURING ANY PRESSURE TESTING OF THAT SYSTEM AT TEST PRESSURES IN EXCESS OF 14"WC (1/2 PSIG or 3.45 kPa).

If the incoming gas pressure is in excess of 14"WC (1/2PSI, 3.45 kPa), a proper step-down regulator will be required.

Step #5: Gas Connection (Continued)

Connect the gas supply directly to the 3/4" male NPT connector located near the lower left rear corner of the fryer. When tightening the supply pipe, be sure to hold the mating connector extending from the unit securely with a wrench. This will prevent any damage or distortion to the internal piping and controls of the unit.

⚠ WARNING

Checking For Gas Leaks: Using a gas leak detector or a soapy water solution is recommended for locating gas leaks. Matches, candle flame, or other sources of ignition shall not be used for this purpose. Check **entire** piping system including the **internal piping** and **Pipe Union** inside of the fryer for leaks. **DO NOT use an open flame to check for leaks. Check all gas piping for leaks with a soap and water solution before operating the unit.**

After connecting the gas supply, check again that the fryer is level. Use a long spirit level four ways; across the front and rear of the frypot, and along each edge.

*** NOTICE ***

Do not restrict the flow of gas. Use only commercially approved gas appliance connectors OR Flexible Hoses! Non-commercial connectors or Flexible hoses will void your warranty.

⚠ WARNING

CONVERTING FRYER FUEL TYPE FROM NATURAL GAS TO PROPANE (LPG), OR PROPANE (LPG) TO NATURAL WILL VOID ALL LIABILITIES AND WARRANTIES.

OPERATION

Lighting



IF YOU SMELL GAS DURING THE LIGHTING PROCEDURE, IMMEDIATELY SHUT OFF THE GAS SUPPLY UNTIL THE LEAK HAS BEEN CORRECTED!

Open the burner compartment door and do the following:

1. Turn thermostat to "OFF"
2. Press down the knob of the combination gas valve, turn it counterclockwise to the "PILOT" position (shown), and continue to press the knob down.

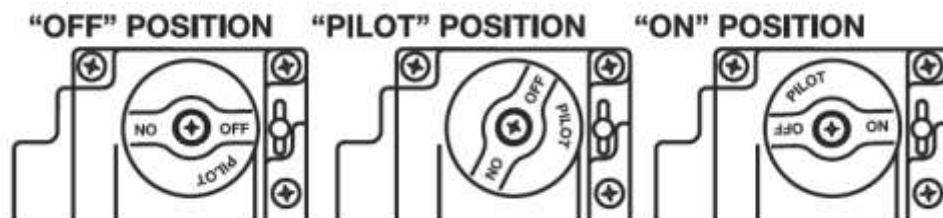

3. While pressing the knob down, use a lit match to ignite the pilot. Continue to press the knob down for about 30 seconds. If the pilot does not stay lit when the knob is released, repeat the lighting procedure and keep the knob down longer. Adjustment of pilot flame may be necessary.
4. When the pilot stays lit, turn the knob counterclockwise to the "ON" position. Do not press down on the knob in this step.
5. Do NOT turn the thermostat "ON" until the frypot is filled with oil or solid shortening.
6. Once the frypot is filled with shortening, set the thermostat to the desired temperature.

Pilot Burner Adjustment

1. Remove pilot adjustment cap.
2. Adjust pilot key to provide properly sized flame on the thermopile. The flame should cover the upper 3/8" of the tip.
3. Replace pilot adjustment cap.

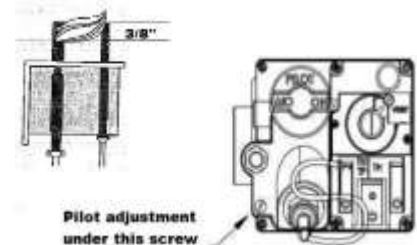

FILLING THE FRYPOT

1. Close drain valve completely before filling the frypot.
2. When the fryer is new, fill the frypot with water and clean thoroughly (see "Weekly Cleaning" on page 14) in order to remove protective coatings and any foreign matter.
3. The recommended solid shortening capacity for the frypot (35, 55 or 75lbs) is described on the serial plate (which is located inside the front door).
4. Remove the basket support frame when filling the frypot with solid shortening.
5. When solid shortening is used, be careful not to bend, break, or twist the thin capillary wires of the sensing elements located in the frypot.

6. Pack solid shortening into the zone below the tubes, all spaces between the tubes, and at least an inch above the top of the tubes before lighting the fryer. If any air spaces are left around the heat tube surfaces when the heat is turned on, the tube surfaces will become red hot, burn the solid shortening, weaken the frypot, and could result in a fire.

 **CAUTION**

NEVER ATTEMPT TO MELT A SOLID BLOCK OF SHORTENING ON TOP OF THE HEAT TUBES. NEVER START THE BURNERS WHEN THE FRYPOT IS EMPTY. THIS WILL CAUSE CRACKED SEAM WELDS AND YOUR FRYER WILL LEAK COOKING OIL, THIS IS AN UNSAFE CONDITION

7. To prevent burning or scorching the solid shortening, keep the thermostat set at the lowest temperature until all the solid shortening between and above the tubes has been melted. Additional solid shortening can then be added until the desired frying depth has been reached.
8. Replace the basket support frame over the frypot heat tubes.

RELIGHTING **CAUTION**

In the event of a main burner ignition failure, a five minute purge period must be observed prior to re-establishing the ignition source.

1. Shut off all gas.
2. Wait five minutes.
3. Follow the "Lighting" procedure described on page 11.

AUTOMATIC PILOT VALVE

The Automatic Pilot Valve provides an automatic safety shutoff for the fryer when the pilot flame is extinguished. When the pilot flame is burning, the valve is held open electromagnetically by the electrical current from a thermopile in the pilot flame. When the pilot flame goes out, generation of current ceases and the valve closes automatically.

HIGH LIMIT CONTROL

Entree Fryers are equipped with a secondary heat control that prevents the oil temperature from rising above 450°F. (Because of the accuracy tolerance of the sensor, the oil temperature may reach as high as 475°F.)

In the event the fryer shuts down due to this condition, the oil must be cooled to below 400°F before the pilot burner can be re-ignited. When the oil has cooled, use the "Lighting" procedure on page 11 to place the fryer back in operation. If the problem persists, contact your Entree Service Representative or the Entree Service Department.

COOKING HINTS

USER TIPS

- Smoking oil means that the temperature is too high, or that the oil has broken down. Time to filter or replace.
- Gum in frypot denotes a need for thorough cleaning (see “Weekly Cleaning” on page 14)
- Use different oil for oily foods (mackerel, nutmeg, etc.) other than for foods with water-soluble flavors (potatoes, onions, etc.).
- Taste cool oil for quality. Replace it regularly.
- Remember, good oil produces good food.

CLEANING

Entree equipment is constructed with the best quality materials and is designed to provide durable service when properly maintained. To expect the best performance, your equipment must be maintained in good condition and cleaned daily. Naturally, the frequency and extent of cleaning depends on the amount and degree of usage.

Following daily and more extensive periodic maintenance procedures will increase the life of your equipment. Climatic conditions (e.g., salt air) may result in the need for more thorough and more frequent cleaning in order to keep equipment performing at optimal levels.

⚠ WARNING : BURN HAZARD

If necessary to move the fryer for cleaning, etc., allow to completely cool, drain the oil first to avoid death or serious injury.

⚠ WARNING

If disconnection of the restraint is necessary to move the appliance for cleaning, etc., reconnect it when the appliance is moved to its originally installed position.

DAILY CLEANING

1. Turn thermostat knob to “OFF” position.
2. Place hot-oil safe container under the drain and drain the frypot completely.
3. Remove the basket support frame (if applicable) and flush out any sediment remaining in the frypot with a little hot oil.
4. Wipe off the basket support frame and the inside of the frypot with a clean cloth.

⚠ CAUTION

SOME AREAS OF THE FRYPOT MAY BE HOT!

5. Close drain valve and strain the oil back into the frypot through several thicknesses of cheesecloth, or filter it back using a filter machine.
6. Replace the basket support frame (if applicable)
7. Add oil or shortening to MIN oil level mark on rear of frypot.
8. To resume cooking, turn the combination gas valve knob to "ON" position.

WEEKLY CLEANING

1. Follow steps 1 through 4 of the Daily Cleaning procedure (see previous section).
2. Close drain valve and fill frypot with a solution of warm water and boil-out compound.
3. Relight the fryer and bring the solution to a gentle boil for at least five minutes.
4. Turn off main burners and let the solution stand until the gum deposits are softened and the carbon spots and burned grease spots can be rubbed off.
5. Scrub the frypot walls and heat tubes, then drain out frypot and rinse it with clean water.
6. Refill the frypot with clean water and boil again.
7. Turn off gas and drain and rinse well until clean.
8. Wipe dry with a clean cloth.
9. Refill as specified in the "Filling the Frypot" section (see page 12).

MONTHLY CLEANING

1. Perform the Weekly Cleaning procedure (see previous section).
2. Clean around burner and orifices if lint has accumulated.
3. Visually check that burner carry-over ports are unobstructed.

CLEANING STAINLESS STEEL SURFACES

To remove normal dirt, grease and product residue from stainless steel use ordinary soap and water (with or without detergent) applied with a sponge or cloth. Dry thoroughly with a clean cloth. Never use vinegar or any corrosive cleaner.

To remove grease and food splatter or condensed vapors that have baked on the equipment apply cleanser to a damp cloth or sponge and rub cleanser on the metal in the direction of the polishing lines on the metal. Rubbing cleanser, as gently as possible, in the direction of the polished lines will not mar the finish of the stainless steel. NEVER RUB WITH A CIRCULAR MOTION. Soil and burnt deposits that do not respond to the above procedure can usually be removed by rubbing the surface with SCOTCH-BRITE scouring pads or STAINLESS scouring pads. DO NOT USE ORDINARY STEEL WOOL, as any particles left on the surface will rust and further spoil the appearance of the finish. NEVER USE A WIRE BRUSH, STEEL SCOURING PADS (EXCEPT STAINLESS), SCRAPER, FILE OR OTHER STEEL TOOLS. Surfaces that are marred collect dirt more rapidly and become more difficult to clean. Marring also increases the possibility of corrosive attack. Refinishing may then be required.

Darkened areas, called "heat tint," sometimes appear on stainless steel surfaces where the area has been subjected to excessive heat. These darkened areas are caused by thickening of the protective surface of the stainless steel and are not harmful. Heat tint can normally be removed by the above cleaning techniques, but tint which does not respond to that procedure calls for a vigorous scouring in the direction of the polish lines, using SCOTCH-BRITE® scouring pads or a STAINLESS scouring pads in combination with a powered cleanser. Heat tint action may be lessened by not applying or by reducing, heat to equipment during slack periods.



Warranty Service– Technical Support (704) 900 2068

A product with the Entrée name incorporates the best in durability and low maintenance. We all recognize, however, that replacement parts and occasional profession service may be necessary to extend the useful live of this unit. When service is needed, contact an Entrée Authorized Service Provider, or your equipment dealer. To avoid confusion, always refer to the model number, serial number and the type of your unit. Thank You!



Conforms to ANSI+
STD Z83.11-2016+
Certified to CSA+
STD 1.8-2016+
Conforms to+
NSF/ANSI STD 4+

Entrée LLC, 4673 OSBORNE DRIVE, SUITE D, EL PASO, TX 79922