



Bottle Cooler

Service, Installation and Care Manual

**Please read this manual completely before attempting to install or operate this equipment.
Notify carrier of damage! Inspect all components immediately. See page 4.**



**IMPORTANT INFORMATION
READ BEFORE USE
PLEASE SAVE THESE INSTRUCTIONS!**

COMMERCIAL REFRIGERATOR SAFETY

Your safety and the safety of others are very important.

We have provided many important safety messages in this manual and on your appliance. Always read and obey all safety messages.

Our product instructions will be uploaded on our company official website.



This is the Safety Alert Symbol. This symbol alerts you to potential hazards that can kill or injure you and others. All safety messages will follow the Safety Alert Symbol and either the words "DANGER", "WARNING" or "CAUTION".



Danger means that failure to heed this safety statement may result in severe personal injury or death.



Warning means that failure to heed this safety statement may result in extensive product damage, serious personal injury, or death.



Caution means that failure to heed this safety statement may result in minor or moderate personal injury, or property or equipment damage.

All safety messages will alert you to what the potential hazard is, tell you how to reduce the chance of injury, and let you know what can happen if the instructions are not followed.

If the supply cord is damaged, it must be replaced by the manufacturer, its service agent or similarly qualified persons in order to avoid a hazard.

This appliance is not intended for use by persons (including children) with reduced physical, sensory or mental capabilities, or lack of experience and knowledge, unless they have been given supervision or instruction concerning use of the appliance by a person responsible for their safety.

Children should be supervised to ensure that they do not play with the appliance.

This appliance can be used by children aged from 8 years and above and persons with reduced physical sensory or mental capabilities or lack of experience and knowledge if they have been given supervision or instruction concerning use of the appliance in a safe way and understand the hazards involved. Children shall not play with the appliance. Cleaning and user maintenance shall not be made by children without supervision.

Keep the appliance and its cord out of reach of children less than 8 years.

Do not store explosive substances such as aerosol cans with a flammable propellant in this appliance.

The appliance use flammable insulation blowing gas C5H10, disposal of the appliance shall in accordance with the regulations of local authorities.

The key for appliance electric box should be safe kept by qualified persons in order to avoid a hazard



Warning; Risk of fire / flammable materials

WARNING: Keep ventilation openings, in the appliance enclosure or in the built-in structure, clear of obstruction.

WARNING: Do not use mechanical devices or other means to accelerate the defrosting process, other than those recommended by the manufacturer.

WARNING: Do not damage the refrigerant circuit.

WARNING: Do not use electrical appliances inside the food storage compartments of the appliance, unless they are of the type recommended by the manufacturer.

Handling, moving, and use of the refrigerator or freezer to avoid either damaging the refrigerant tubing, or increasing the risk of a leak

L'opération, le mouvement et l'utilisation du réfrigérant ou le congélateur doivent éviter les dommages du tuyau réfrigérant ou le risque de la fuite.

Caution – Risk of Fire or Explosion due to Flammable Refrigerant Used. Follow Handling Instructions Carefully in Compliance with U.S. Government Regulations.

Component parts shall be replaced with like components and that servicing shall be done by factory authorized service personnel, so as to minimize the risk of possible ignition due to incorrect parts or improper service.

Les pièces de rechange doivent être remplacées par les composants relatifs et les opérations doivent être faites par les professionnels afin de minimaliser le risque d'allumage à cause des parts incorrects ou des opérations impropres.

CAUTION – Risk Of Fire Or Explosion Due To Puncture Of Refrigerant Tubing; Follow Handling Instructions Carefully. Flammable Refrigerant Used

DANGER: Risk of child entrapment. Before you throw away your old refrigerator or freezer:

Take off the doors

Leave the shelves in place so that children may not easily climb inside



CONTENTS

SPECIFICATIONS.....2

CONGRATULATIONS ON YOUR NEW COOLER.....2

INSTALLATION.....3

ELECTRICAL CONNECTION.....3

OPERATION INSTRUCTIONS.....3

STORAGE OF PRODUCT.....3

DEFROSTING THE CABINET.....3

MAINTENANCE.....3

OPERATION.....4

TROUBLE SHOOTING.....6

DISPOSAL.....6

SPECIAL POINTS TO NOTE.....6

CIRCUIT DIAGRAM.....7

STANDARD WARRANTIES.....8

All rights reserved. Reproduction without written permission is prohibited.



is a registered trademark of Entree LLC.

SPECIFICATION

MODEL#	V/Hz/Ph	AMPS	STORAGE CAPACIT	HP	BTU	CHARGE OZ	SHIP WEIGHT LBS	NEMA PLUG	FREON TYPE
BST-36-HC	115/60/1	1.8	10	3/8	2000	2.12	161	5-15P	R600
BST-50-HC	115/60/1	3.0	15	1/2	3200	2.47	310	5-15P	R600
BST-65-HC	115/60/1	3.0	20	1/2	5400	3.17	353	5-15P	R600
BST-94-HC	115/60/1	3.3	26	1/2	7600	3.53	439	5-15P	R290

CONGRATULATIONS ON YOUR NEW COOLER

Note these instructions apply to all coolers. Installations of equipment may not exactly correspond to your model.



INSTALLATION

Make sure that the cooler is not damaged on arrival. Your supplier must be notified of any transport damage, within 24 hours of delivery. The cooler should be placed in a warm, dry room, with suitable ventilation. Place the cooler in such a way, as to allow the free circulation of air around it. That is, with at least four (4) inches space all around it. Never place the cooler in strong sunlight. The cooler be placed on a level surface. Make sure that it does not rock. If the cooler has been stored or transported cold, it must not be started before the compressor is judged to have reached a temperature at least 40°F. It is recommended to clean up the cooler before starting it.

ELECTRICAL CONNECTION

The cooler must be connected to a socket with the correct voltage/frequency, as show on the nameplate. The standard for U.S. is 115V/60HZ. Voltage variations of $\pm 10\%$ are acceptable. Greater variations can damage the cooler, and in such cases the factory warranty is not valid. In the case of extreme voltage variation, above or below the standard, your local supplier will be able to advise you, what to do.

This also applies, if a new cooler is replaced, which did not have such protection. The purpose of extra protection, is to protect the user from dangerous electric shocks, in the case of defect.

OPERATION INSTRUCTIONS

The temperature in the cooler is automatically regulated by a readjusted thermostat.

The position of the cooler, the ambient temperature, the number of times the lid is opened and for how long the lid is opened, all these factors affect the temperature in the cooler, which should therefore not be placed in sunlight or closed to a heat-radiating surface.

If your cooler is fitted with a lock, the key should be kept out of the reach of children. If your new cooler is to replace an older one, which is not in use any more, you should remove the lock mechanism, on the old one, before disposing it.

STORAGE OF FOOD

The cooler is only designed as a conserver, and is the not suited to cold freeze food product. In other words, only refrozen food must be placed in the cooler. Next to that the cooler must not be filled beyond the height limit of the contents line, or in cases where there is no such line, to within 100mm below the lid. This is to ensure the product temperature less than 34°F.

DEFROSTING THE CABINET

In the course of time, a frost layer will be naturally formed within the cooler.

When this layer is $\frac{1}{8}$ " to $\frac{1}{4}$ " thick, the cabinet should be defrosted the following way:

- remove the plug from the socket;
- open the lid and leave it open;
- loosen the frost layer using a plastic or wooden scraper.

The defrosting process can be speeded up by using bowls of hot water.

Never use sharp or pointed instruments

After final defrosting, the cabinet should be cleaned as described in section: Maintenance. the cabinet should be thoroughly dried after cleaning.

OPERATION



CAUTION

Do not throw items into the storage area. Failure to heed these recommendations could result in damage to the interior of the cabinet.

Refrigerated cycle

Refrigerators: During the refrigeration cycle, the evaporator fans will run continuously even when one or more doors are open. The door switch will activate the lights when opened.

1. Every 6 hours, the unit will turn off and to allow the evaporator coil to defrost. The controller now displays the defrost symbol. When the coil temperature reaches 41°F or after 20 minutes of defrost, the unit will turn on again.
2. Anti-condensation heaters on door frames work in conjunction with the compressor.
3. The factory setting for the temperature range is 34°F to 38°F.

SOLID-STATE THERMOSTAT DESCRIPTIONS

1. FRONT PANEL COMMANDS

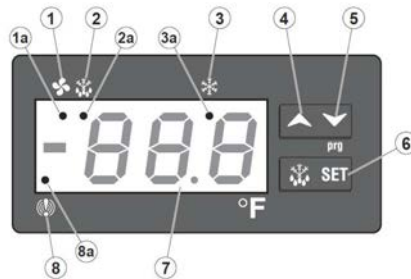

SET: ⑥ To display target set point; in programming mode it selects a parameter or confirms an operation.

❄️ (DEF) ② To start a manual defrost

▲ (UP) ⑤ To view the latest alarm occurrence; in programming mode it browses the parameter codes or increases the display value

▼ (DOWN) ④ To view the latest alarm occurrence; in programming mode it browses the parameter codes or decreases the display value

KEY COMBINATION

▲ + ▼ ④+⑤ To lock & unlock the keyboard

SET + ▼ ⑥+⑤ To enter in programming mode

SET + ▲ ⑥+④ To return to the room temperature display

1.1 Function of LEDs



LED	MODE	FUNCTION
❄️	ON	Compressor enabled
❄️	Flashing	- Programming Phase (flashing with ❄️) - Anti-short cycle delay enabled
❄️	ON	Defrost enabled
❄️	Flashing	- Programming Phase (flashing with ❄️) - Drip time in progress
🌀	ON	Fans enabled
🌀	Flashing	Fans delay after defrost in progress.
🔊	ON	An temperature alarm happened

2. MAIN FUNCTIONS

2.1 HOW TO SEE THE SETPOINT

1. Push and immediately release the **SET** key: the display will show the set point value. 
2. Push and immediately release the **SET** key or wait for 5 seconds to display the sensor value again.

2.2 HOW TO CHANGE THE SETPOINT



1. Hold the **SET** key for more than 2 seconds to change the set point value.
2. The value of the set point will be displayed and the  LED starts blinking.
3. To change the set value push the  or  key within 10 seconds.
4. To set a new point value, push the **SET** key again or wait 10 seconds.

2.3 HOW TO START A MANUAL DEFFROST

Hold the  key for more than 2 seconds and the manual defrost will start





2.4 HOW TO LOCK THE KEYBOARD

1. Hold the  and  keys for more than 3 seconds.
2. The "POF" message will be displayed and the keyboard will be locked. At this point, it will be possible only to see the set point or the MAX or Min temperature stored.
3. If a key is pressed more than 3s the "POF" message will be displayed.





2.5 HOW TO UNLOCK THE KEYBOARD

Hold the  and  keys together for more than 3s, till the "POF" message is displayed.

3. ALARM SIGNALS

HOW TO SEE THE ALARM AND RESET THE RECORDED ALARM

1. Hold the  or  key to display the alarm signals.
2. When the signal is displayed, hold the **SET** key until the "rst" message is displayed, and push the **SET** key again. The "rst" message starts blinking and the normal temperature will be displayed.

Message	Cause	Outputs
"P1"	Room probe failure	Compressor output according to par. "Con" and "COF"
"P2"	Evaporator probe failure	Defrost end is timed
"P3"	Condenser probe failure	Outputs unchanged.
"HA"	Maximum temperature alarm	Outputs unchanged.
"LA"	Minimum temperature alarm	Outputs unchanged.
"dA"	Door open	Compressor and fans restarts
"EA"	External alarm	Output unchanged.
"CA"	Serious external alarm (i1F=bAL)	All outputs OFF.
"CSd"	Condenser alarm	All outputs OFF.

MAINTENANCE

This cooler can be cleaned using warm water and a mild detergent. Rinse with clean water to finish off.

Never use detergents that contain chlorine.

The lid may be cleaned in the same way as the cooler.

If a condenser and associated fan are fitted at the back bottom of the cooler, they can gather dust and dirt. If cleaning is necessary, they should be vacuumed with a soft brush.

Please note that the parts behind the protective grille can be hot and rotating.

TROUBLE SHOOTING

If you are having problems with your cooler, please check the following point before calling service personnel:

- Is the cooler connected to the power supply?
- Is the socket switch on?
- Is the fuse in the switch cabinet intact?
- Has the earth leak circuit breaker (if there is one) cut out?
- Has there been power cut?

If the cooler is in a place that is very hot or with bad ventilation, make sure to provide adequate ventilation. If the condenser mentioned in Section Maintenance is not clean, make sure to vacuum it.

If the above points have been checked and the cooler is still not working, please call service personnel. Inform them the nature of the problem, the type of cooler, serial number and item number (provided on the nameplate at the back of the cabinet).

Do not open the cabinet, as every opening hastens the thawing point. As a rule, the goods will not suffer damage at the first 12 hours. If more time passes, the goods must be moved to another cooler.

DISPOSAL

When a worn-out cooler is to be disposed off, this must be done in a correct manner, with respect to the environment. Please be aware of the rules covering the disposal of such terms; there may be special requirements or conditions to be observed.

Information about disposal may be obtained from:

- your supplier;
- the relevant authorities (the Local Authority, environmental agencies, etc.).

SPECIAL POINTS TO NOTE

The information contained in these instructions for use, was correct at the time of printing. On account of our constant product development, however, we reserve the right to make changes in the cooler described here. Naturally, we will attempt to keep instructions for use up to date.

If you are in doubt as to the correct use of the cooler, please contact your supplier, who will be able to advise you.

The producer is not responsible for accidents or problems, occurred as a result of wrong connection of the cooler.

CIRCUIT DIAGRAM

MODEL: BST-36 / BST-50 / BST-65

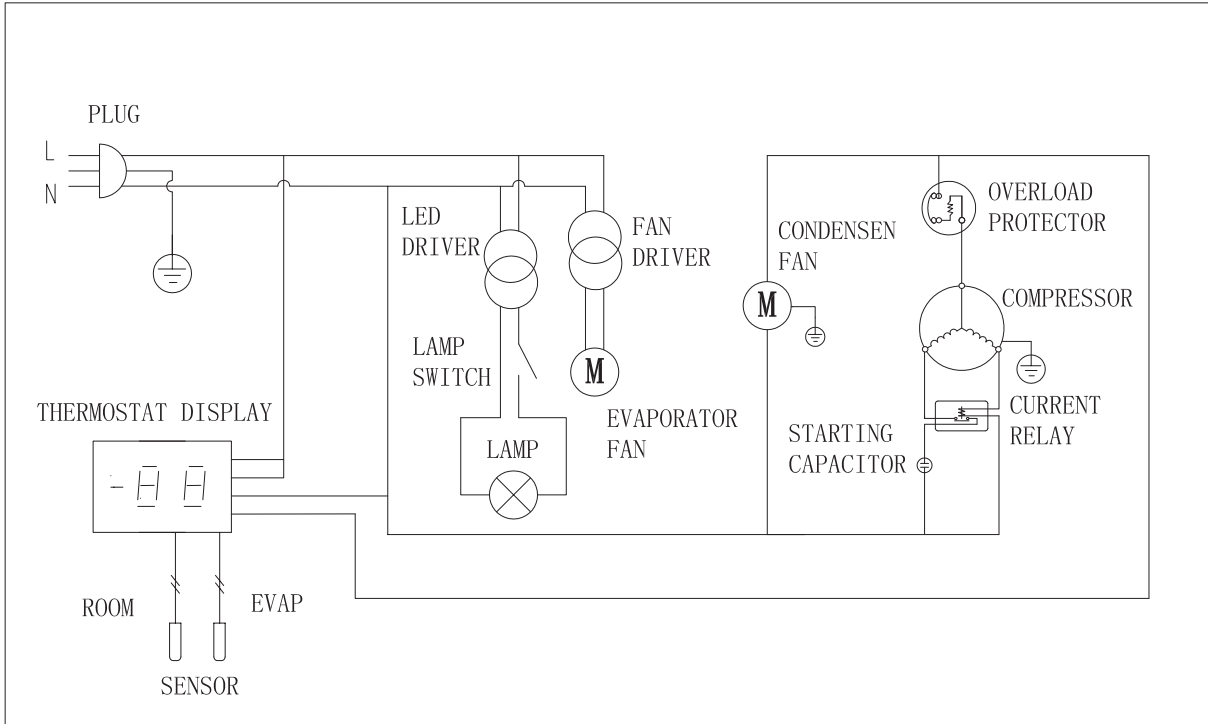

MODEL: BST-94

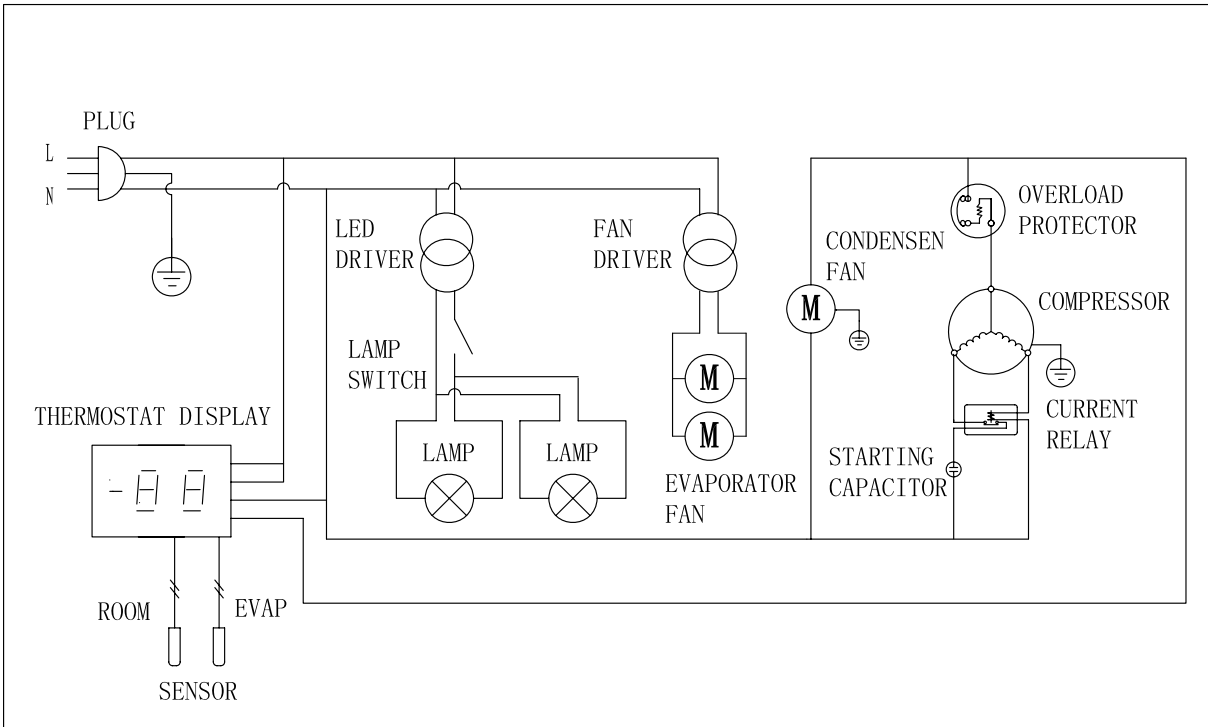



ENTRÉE LLC

4673 OSBORNE DRIVE SUITE D

EL PASO, TX 79922

Warranty Service- Technical Support

(704) 900 2068