

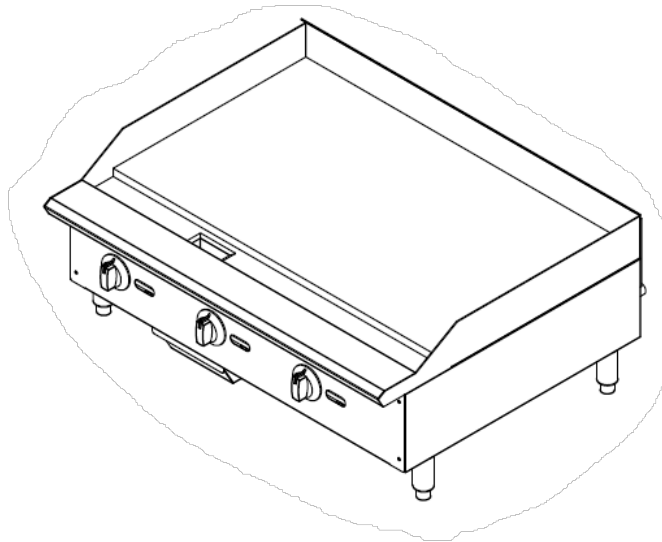

Commercial Cooking Equipment

INSTALLATION & OPERATION MANUAL

GAS COUNTER SERIES GRIDDLES



⚠ WARNING

This manual contains important information regarding your ENTREE unit. Please read the manual thoroughly prior to equipment set-up, and operation maintenance. Failure to comply with regular maintenance guidelines out-lined in the manual may void the warranty. Improper installation, adjustment, alteration, service or maintenance can cause property damage, injury or death. Read this manual thoroughly before installing or servicing this equipment.



MUST READ!

**Warranty Service– Technical Support
(704) 900 2068**

SAFETY PRECAUTIONS

Before installing and operating this equipment, be sure everyone involved in its operation is fully trained and aware of precautions. Accidents and problems can be caused by failure to follow fundamental rules and precautions.

The following symbols, found throughout this manual, alert you to potentially dangerous conditions to the operator, service personnel, or to the equipment.

 WARNING	This symbol refers to a potential hazard or unsafe practice that could result in injury or death.
 CAUTION	This symbol refers to a potential hazard or unsafe practice that could result in injury, product damage, or property damage.
 NOTICE	This symbol refers to information that needs special attention or must be fully understood, even though not dangerous.

FOR YOUR SAFETY TO AVOID SERIOUS PERSONAL INJURY AND PROPERTY DAMAGE:

- **ALWAYS** install equipment in a work area with adequate light and space.
- **ONLY** operate on a solid, level, nonskid surface that is nonflammable and away from sinks and water hazards.
- **NEVER** bypass, alter, or modify this equipment in any way from its original condition. Doing so may create hazards and will void warranty.

 WARNING FIRE HAZARD FOR YOUR SAFETY Do not store or use gasoline or other flammable vapors and liquids in the vicinity of this or any other appliance. Keep area around appliances free and clear of combustibles. Purchaser of equipment must post in a prominent location, detailed instructions to be followed in the event the operator smells gas. Obtain the instructions from the local gas supplier

 NOTICE ENTREE Griddles are intended for commercial use only. Not for household use. Warranty will be void if service work is performed by other than an authorized technician, or if other than genuine ENTREE replacement parts are installed. Be sure this Operator's/Installer's Manual and important papers are given to the proper authority to retain for future reference. <p style="text-align: center;">For warranty Service on your ENTREE Gas Counter Griddle call (704) 900 2068 Be sure to have your model and serial number when calling.</p>

Congratulations! You have purchased one of the finest pieces of commercial cooking equipment on the market. You will find that your new equipment, like all ENTREE equipment, has been designed and manufactured to meet the toughest standards in the industry. Each piece of ENTREE equipment is carefully engineered and designs are verified through laboratory tests and field installations. With proper care and field maintenance, you will experience years of reliable, trouble-free operation. For best results, read this manual carefully.

RETAIN THIS MANUAL FOR FUTURE REFERENCE

Table of Contents

Specifications-----	Page 3
Installation-----	Page 5
Operation-----	Page 9
Seasoning-----	Page 10
Cleaning-----	Page 10
Service/Trouble Shooting-----	Page 12
Parts-----	Page 13
Warranty-----	Page 14

Read these instructions carefully before attempting installation. Installation and initial startup should be performed by a qualified installer. Unless the installation instructions for this product are followed by a qualified service technician (a person experienced in and knowledgeable with the installation of commercial gas and/or electric cooking equipment) then the terms and conditions on the Manufacturer's Limited Warranty will be rendered void and no warranty of any kind shall apply.

SPECIFICATIONS

GAS and GAS PRESSURE

⚠ CAUTION This unit is factory supplied in Natural Gas. This unit can be converted to L.P. gas by a licensed and certified gas technician. Documentation may be necessary for warranty issues. Failure to comply with this instruction will void warranty. **See the included L.P. conversion kit for gas conversion parts and instructions.**

⚠ WARNING Unit installation must conform to the National Fuel Gas Code, ANSI Z223.1/NFPA 54, the National Gas Installation Code, CSA-B149.1, or the Propane Installation Code, CSA-B149.2 as applicable and in accordance with local codes.

⚠ WARNING The appliance and its individual shutoff valve (to be supplied by user) must be disconnected from the gas supply piping system during any pressure testing of that system at test pressures in excess of 1/2" P.S.I. (3.45kPa).

These models are designed, built, and sold for commercial use only.

Instructions must be posted in a prominent location. All safety precautions must be taken in the event the user smells gas. Safety information can be obtained from your local gas supplier.

SPECIFICATIONS (Continued)

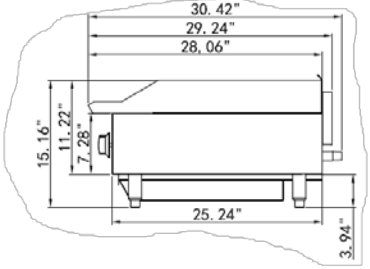
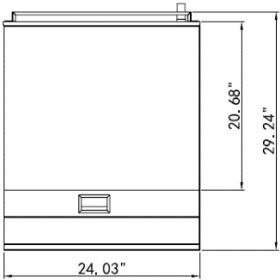
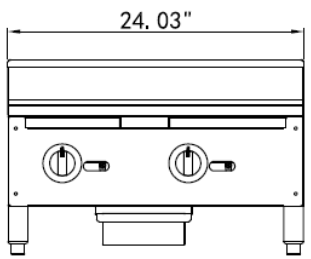
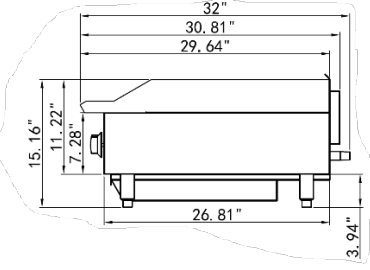
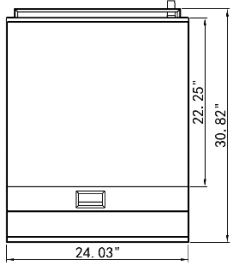
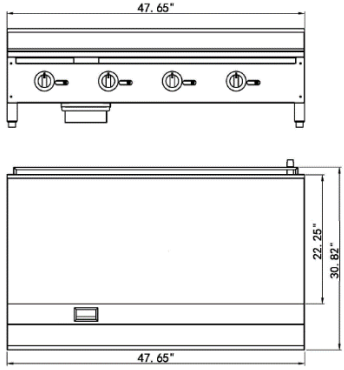
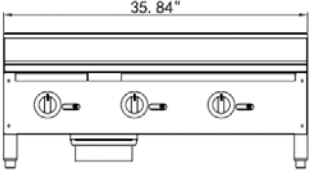
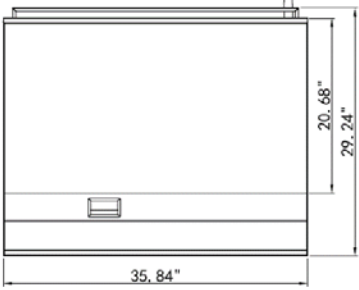
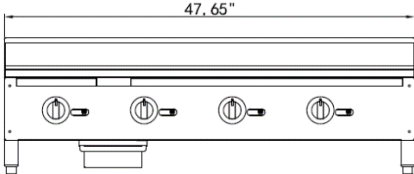
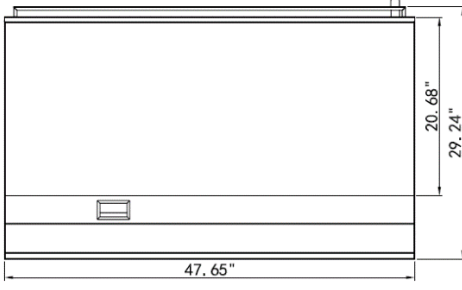
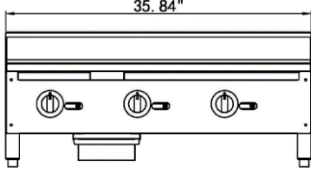
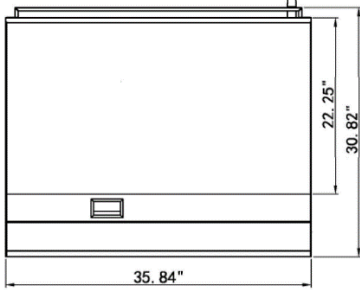
 <p>Use for all Manual Griddles</p>	 <p>24" Manual Griddle Top</p>	 <p>24" Manual & Thermostat Griddle Front</p>
 <p>Use for a Thermostat Griddles</p>	 <p>24" Thermostat Griddle Top</p>	 <p>48" Thermostat Griddle</p>
  <p>36" Manual Griddle</p>	  <p>48" Manual Griddle</p>	  <p>36" Thermostat Griddle</p>

Model	Description	BTU.hr	Number of Burners	Gas Type
GR24 GR24T	Gas Griddle 24"	60,000	2	Natural Gas or Propane*
GR36- GR36T	Gas Griddle 36"	90,000	3	Natural Gas or Propane*
GR48 GR48T	Gas Griddle 48"	120,000	4	Natural Gas or Propane*

*Shipped setup for Natural Gas and includes a kit for conversion to Propane Gas

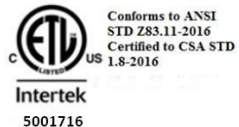

UNPACKING

Unpack the Griddle immediately after receipt. Remove the Gas Griddle from the crate; remove all packaging on and surrounding the unit and be certain to remove all protective plastics and residues from all surfaces. Make sure that all parts provided including the L.P. gas conversion kit are located. Equipment must have the legs properly installed before use. Before using this equipment it must be cleaned and dried thoroughly.

INSTALLATION

NOTE: it is vital that the purchaser of this equipment post in a prominent location instructions to be followed in the event that the user smells gas. This information shall be obtained by consulting the local gas supplier. The purchaser of this equipment must post in a prominent location.

1. Read this manual thoroughly before installation and operation. DO NOT proceed with installation and operation if you have any questions or do not understand anything in this manual. Contact your local representative or ENTREE first.
2. Select a location for the Griddle that has a level, solid, nonskid surface that is nonflammable and away from water hazards or sinks, and is in a well-lighted work area away from children and visitors.
3. This equipment must be installed under a proper ventilation as required by local code.
***NOTICE** Local codes regarding installation and ventilation vary greatly by area. The National Fire Protection Association states in its NFPA 96 latest edition (see NFPA page at the beginning of this manual) that local codes are “authority having jurisdiction” when it comes to requirements for installation of equipment. Therefore, installation should comply with all local codes.
4. Screw legs into (A) the permanently fastened nuts on the four corners of the unit and tighten by hand. Legs must be installed to adequately provide proper ventilation to the unit.
5. Level unit by adjusting the four feet and tighten securely. The adjustable feet have an adjustment of one inch. Do not slide unit with legs mounted. Lift if necessary to move unit.
6. The supplied gas pressure regulator is factory set at 4” Natural Gas W.C. or 10” Propane Gas.
7. THESE UNITS ARE SUITABLE FOR INSTALLATION ON NON-COMBUSTIBLE SURFACE ONLY. Noncombustible clearances: 6” sides (152 mm), 6” rear (152 mm), 4” floor (102 mm).
8. Do not obstruct the flow of combustion and ventilation air under the unit by the legs or behind the unit by the flue. Do not place objects between the bottom of the unit and the counter top.
9. There must be adequate clearance for removal of the front panel. All major parts except the burners are removable through the front if the gas is disconnected.
10. It may be necessary to adjust the balance of gas volume and air supply to each burner. This must be done by and authorized service technician.
11. Pipe threading compound must be resistant to the action of liquefied petroleum gas. DO NOT USE TEFLON TAPE.

⚠WARNING DO NOT use an open flame to check for leaks. Check all gas piping for leaks with a soap and water solution before operating the unit.

The installation of this appliance must conform to local codes, or In the absence of local codes, the National Fuel Gas Code, ANSI Z223.1/NFPA 54, or the Natural Gas and Propane Installation Code, CSA B149.1, as applicable.

- The appliance and its individual shut off valve must be disconnected from the gas supply piping system during any pressure testing of that system at test pressures in excess of ½ PSI (3.5kPa).
- The appliance must be isolated from the gas supply piping system by closing its individual manual shut off valve during any pressure testing of the gas supply piping system at test pressures equal to less than ½ PSI (3.5kPa).

Clearance and positioning around the appliance: This appliance must be installed adjacent to non-combustible surfaces only with a minimum spacing of six (6") inches from all sides. This appliance must be a minimum distance of six (6") inches from another appliance. The appliance must have the supplied four (4") inch legs installed and be placed on a non-combustible surface.

Air supply and ventilation: The area in front and around the appliances must be kept clear to avoid any obstruction of the flow of combustion and ventilation air. Adequate clearance must be maintained at all times in front and at the sides of the appliance for servicing and proper ventilation.

Pressure Regulator: All commercial cooking equipment must have a pressure regulator on the incoming service line for safe and efficient operation. The regulator provided for this appliance is adaptable for both Natural Gas and Liquefied Propane (LP) Gas. A conversion kit with separate instructions is included explaining this procedure in detail.

Regulator information: 3/4" NPT (National Pipe Thread) inlet and outlet; factory adjusted for four (4") inch Water Column (WC) Natural Gas standard and may be converted by qualified personnel to be used for Propane at ten (10") Water Column pressure.

Prior to connecting the regulator, check the incoming line pressure. The regulator can only withstand a maximum pressure of 1/2 PSI (14" WC). If the line pressure is beyond this limit, a step down regulator before the regulator provided will be required. The arrow forged into the bottom of the regulator body shows gas flow direction, and should point downstream to the appliance.

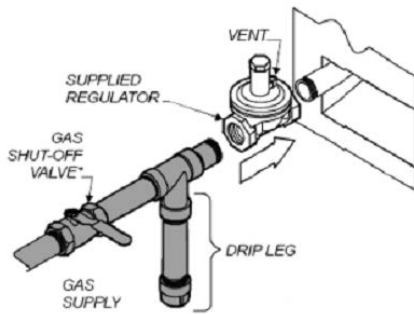

Connection diagram

Gas Conversion: Conversion from Natural Gas to Liquefied Propane (LP) or vice versa may only be performed by the factory or its authorized service agent. In the case of troubleshooting, ensure that the correct orifice sizes of the spuds have been provided.

Natural Gas Orifice: #36dms(Thermostatic)/#37 dms(Manual)

Liquefied Propane (LP) Orifice #51 dms(Both Thermostatic and Manual)

NOTE: The orifice size is marked on the spud.

Gas Connection: The appliance comes fitted with a 3/4" NPT (National Pipe Thread) male adapter for connection to the pressure regulator.

Maintenance: A qualified service company should check the unit for safe and efficient operation on an annual basis. Contact the factory representative or local service company to perform maintenance and repairs.

Gas Piping: Gas piping shall be of such size and so installed as to provide a supply of gas sufficient to meet the full gas input of the appliance. If the appliance is to be connected to existing piping, it shall be checked to determine if it has adequate capacity. Joint compound (pipe dope) shall be used sparingly and only on the male threads of the pipe joints. Such compounds must be resistant to the action of Liquefied Propane (LP) gases.

CAUTION Any loose dirt or metal particles, which are allowed to enter the gas lines on this appliance, will damage the valve and affect its operation. When installing this appliance, all pipe and fittings must be free from any internal contaminants. It is recommended that a "drip leg" be installed in-line before the regulator.

Manual Shut Off Valve: A manual shut off valve should be installed upstream from the manifold, within four (4) feet, (1.2M) of the appliance and in a position where it can be reached in the event of an emergency.

Checking For Gas Leaks: Using a gas leak detector or a soapy water solution is recommended for locating gas leaks. Matches, candle flame, or other sources of ignition shall not be used for this purpose. Check entire piping system for leaks.

Exhaust Canopy: Cooking appliances inherently create a good deal of heat and smoke and should be installed under an efficient exhaust hood with flame proof filters. A vertical distance of not less than four (4) feet shall be provided between the top of the appliance and filters or any other combustible material.

⚠️WARNING FIRE DEATH HAZARD If you smell gas follow the instruction provided by the gas supplier. Do not touch any electrical switch; do not try to light the burner; do not use a telephone within close proximity.

Lighting the Pilot: The manifold units are equipped with a standing pilots and each should be lit immediately after the gas is supplied to the appliance.

1. Before attempting to light pilots, turn off the main gas valve to the appliance and wait five (5) minutes to clear the gas.
2. Turn off all gas control knobs (E). See figure 1.
3. Turn on main gas valve and light all pilots.
4. The pilot burner must be lit at the end of the tube. Hold an ignition source through the pilot light hole (D) in the front panel at the pilot tube. When the flame is established remove ignition source.
5. To shut down the appliance, turn off the main gas valve to the appliance.

NOTE: Smoke appearing on initial use of the appliance is normal. This is a result of the rust preventative coating burning off. This will occur for at least fifteen (15) minutes during the first use or seasoning process.

Pilot Flame Regulation: The pilot flame on the appliance has been factory adjusted. When adjustment is necessary, adjust the pilot flames as small as possible, but high enough to light the burner immediately when burner valve is turned to the "HIGH" setting. Access to the pilot flame adjustment screw is obtained by removing the front panel.

Burner Adjustment: Remove the front panel to gain access. Turn burner valve knob to "HIGH" position. Slowly decrease mixing ring aperture to give a soft blue flame having luminous tips, then slowly increase opening to a point where the yellow tips disappear and a hard blue flame is obtained.

COMMISSIONING: Commission of your new Griddle is of the utmost importance. Commissioning is the thorough and methodical testing of the equipment, subsystems, and systems to ensure that the final product functions properly and safely at the work site. By identifying any potential problems (i.e.: equipment location, ventilation, local fire/electrical codes, installation, operator training, and certification) prior to equipment being placed into service, costly outages and potential damages may be avoided.

⚠️WARNING Improper installation, adjustment, alteration, service or maintenance can cause property damage, injury or death. Read the installation, operating and maintenance instruction thoroughly before installing or servicing this equipment.

⚠️WARNING FIRE HAZARD
Do not install or use without 4" legs. Use of this equipment without legs can cause the appliance to overheat and cause a fire.

ALWAYS SAFETY FIRST!

⚠️ WARNING FIRE, INJURY or DEATH HAZARD This appliance is for use in non-combustible location only

⚠️ WARNING FIRE, INJURY or DEATH HAZARD

This equipment must be installed by a qualified installer in accordance with all federal, state and local codes. Failure to install this equipment properly can result in injury or death.

⚠️ WARNING FIRE and INJURY or DEATH HAZARD

Injuries or death can occur if this equipment is not used properly. To reduce risk of injury or death:

- Keep the appliance area free and clear from combustibles
- Do not obstruct the flow of combustion and ventilation air
- Do not spray controls or the outside of the appliance with liquids or cleaning agents
- Let hot appliance cool before cleaning or moving
- The appliance should only be used in a flat, level position
- Do not operate unattended

IMPORTANT SAFEGUARDS & SAFETY INSTRUCTIONS

⚠️ CAUTION When using gas cooking equipment, basic safety precautions should always be followed, including the following:

The Griddle outside surfaces may become HOT after use. Use caution when touching the unit.

- Never directly touch the cooking surface while the Griddle is on.
- Always turn off the unit when not in use, servicing or adjusting any parts or attachments, and before cleaning.
- Never leave the Griddle on overnight.
- Do not operate any equipment with a damaged or leaking gas line, ignitor or valve, or if the unit is dropped or damaged in any manner. Call for Service.
- The use of attachments not recommended or sold by the manufacture may cause fire, injury or even death.
- DO NOT USE OUTDOORS.
- Do not use this equipment for any use other than the use intended by the manufacturer.
- Never use the Griddle as a heating source.
- The Griddle does not contain **any** user-serviceable parts. Dealer or recommended qualified technicians should carry out repairs. Do not remove any components or service panels on this product.
- Never bypass, alter, modify, or attach any unauthorized parts to this equipment. Doing so may create a hazard and will void warranty.
- We take every care to ensure that all products are safe. Steel cutting procedures used to manufacture these items result in sharp edges. These sharp edges are removed to the best of our ability; however, we insist the operator take care when in contact with this piece of equipment.
- Always keep hands, hair, and clothing away from heating source.
- Allow the Griddle to cool down after use and before dismantling for cleaning; the unit will be too hot to handle immediately after use.
- DO NOT USE ICE TO COOL DOWN THE GRIDDLE PLATE. This will cause the Griddle plate to warp and render it unusable.

OPERATING INSTRUCTIONS

Operating the Griddle – Pilot Lighting Instructions for MANUALLY & THERMOSTAT CONTROLLED GRIDDLES

Before operating Griddle, it should be checked to see that is sitting level. Adjust the feet to level the Griddle. Be sure the catch tray had been properly placed.

The pilot light on the appliance has been set at the factory. Each burner has a pilot light.

1. Make sure all knobs are in the "OFF" position.
2. The main gas valve should be "CLOSED/OFF" for five (5) minutes prior to lighting pilots to clear any existing gas. (Main gas valve is supplied by others.)
3. Turn "ON or OPEN" the main gas valve to the unit.
4. Light and hold an ignition source (match) at the pilots. When the flame is established, remove the ignition source. Repeat this step for each burner as each burner has its own individual pilot. The pilot can be reached through the holes in the front of the unit.
5. Turn each burner knob "ON". If the burners do not ignite promptly, turn the knobs "OFF". From the opening in the front panel, use a screwdriver and turn the pilot valve screw counterclockwise, which will increase the flame height and repeat step 4.

If the pilot flame appears large than necessary, turn it down and retest the burner ignition. The pilot flame should be as small as possible but large enough to guarantee reliable ignition of the burners when the knobs are turned to "ON". In the holes located in the front panel are pilot valve adjustments. Use a screwdriver to turn the valve to adjust the flame height to your desired level.

⚠ CAUTION All burners are lit from constantly burning pilots. Turning the valve to the desired flame height is all that is required to put the unit in service.

Igniting the Burner

To ignite the burner, turn knob to the "ON" position, then back off to the desired flame level. The range of adjustment is virtually infinite between "ON" and "OFF". On the Thermostat controlled griddle, turn the knob to the desired temperature and allow it to preheat for approximately fifteen (15) minutes. (*Be sure the griddle plate has been properly season before attempting to cook). The space between the legs at the bottom admits combustion air. DO NOT BLOCK THIS SPACE.

All burners are lit from a constantly burning pilots. Turning the valve to the desired flame height is all that is required to put the unit in service. Or if thermostatically controlled, simply set to the desired temperature.

Do not permit fans to blow directly at the unit. Whenever possible, avoid open windows next to the unit's sides or back. Avoid wall type fans which create air cross-currents within a room.

It is also necessary that sufficient air should be allowed to enter the room to compensate for the amount of air removed by any ventilation system. Otherwise, a subnormal atmospheric pressure will occur, affecting operation and causing undesirable working conditions.

A properly designed and installed hood will act as the heart of the ventilation system for the room or area in which the unit is installed, and will leave the unit independent of changing draft conditions.

NOTE: It may be necessary to adjust the balance of gas, volume, and air supply to each burner. This must be done by an authorized service technician.

SEASONING THE GRIDDLE

Be sure to start with a clean Griddle surface. Pour small amount of high quality cooking oil to the griddle plate (about one ounce (30 cc) per square foot of surface). Spread the oil over the entire griddle surface with a clean cloth to create a thin film. Turn on the griddle to the lowest flame height or the lowest setting on the dial if it is a thermostatically controlled griddle, and allow to heat for approximately 30 minutes. As the griddle is heating it will be necessary to spread the oil over the griddle surface to prevent it from drying. Repeat this process 2 to 3 times gradually increasing the flame height each time or increase the temperature by turning the dial up 100 degrees at a time, on the burner until the griddle has a slick, mirror-like surface. This process will take 1 ½ to 2 hours.

Note: Each time the griddle is cleaned with soap and WATER, the seasoning is removed and this process must be repeated.

Note: If the process occurs too fast the griddle surface may turn a light bluish tint in color. The tint does not hurt the griddle surface. You should allow the surface to cool and start over.

OPERATING THE GRIDDLE

Turn the burners on about 15-20 minutes before cooking for preheating. Set the knobs to the desired flame height or temperature.

NOTE: *On Manually Operated Griddles there is NO TEMPERATURE CONTROL, you, the operator must maintain temperature by increasing or decreasing the flame height as required.*

Each valve controls the gas flow to the burner to bring that area of the griddle up to the desired temperature. If different temperature settings are to be used, adjoining areas should be set to progressively higher temperatures using the lowest temperature on the outside burners. A uniform and systematic approach to the loading of the unit will produce the most consistent product results.

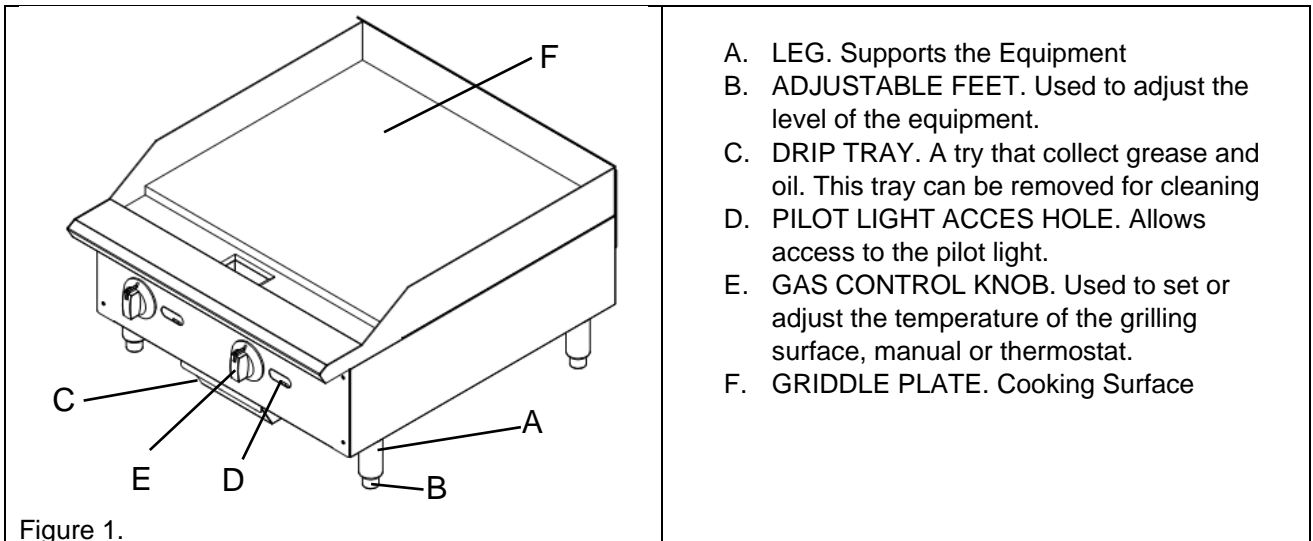

CLEANING INSTRUCTIONS

CAUTION

- **DO NOT** use any abrasive or flammable cleaning fluids.
- **DO NOT** hose down, immerse, or pressure wash any part of the Griddle, excluding the catch tray.
- **NEVER** use a scrubber pad (on all exterior surfaces, except the griddle plate), steel wool or abrasive material, or cleaners containing chlorine, iodine and ammonia, or bromine chemicals as these will deteriorate the stainless steel and shorten the life of the unit.

CLEANING INSTRUCTIONS (Continued)

⚠ CAUTION IF CLEANING ALL THE GRIDDLE'S SURFACES, THE MAIN GAS VALVE MUST BE SWITCHED TO THE CLOSED POSITION. AFTER CLEANING, THE GAS LINE CAN BE SWITCHED BACK TO THE OPEN POSITION. PLEASE FOLLOW THE LIGHTING INSTRUCTION IN THE MANUAL TO RELIGHT THE GRIDDLE'S PILOTS AS NEEDED.

Recommended Cleaning

It takes very little time and effort to keep the Griddle attractive and performing at top efficiency. Wait until the griddle is cool after the unit had been turned off. Please follow the cleaning steps below:

PART	REQUIRED ACTION	FREQUENCY
Body	Use a clean cloth and a non-abrasive cleaner to clean the stainless steel body of the Griddle. Wipe the polished areas with a soft cloth.	Daily
Back and Side Splashes	Thoroughly clean. Wipe with clean, warm medley soapy water then re-wipe splashes with a damp cloth.	Daily
Controls	Unit should be turned off when not in use. It is recommended that the unit be disconnected from the gas supply by closing the main gas valve. Use a clean cloth to wipe any grease or debris from the control knobs.	Daily
Griddle Plate	Clean surface with a grill pad or metal spatula. <ul style="list-style-type: none"> • Clean the griddle surface thoroughly. If necessary, use a griddle stone or grill pad. (If a griddle stone is not used correctly it will damage the Griddle surface). • Rub with the grain of the metal while the griddle is still warm. A mild soap may be used on the plate surface to help clean it. • Remove all soap and debris thoroughly; wipe with a clean, damp cloth. • The plate should then be covered with a thin film of oil to prevent rusting. • Clean stainless surfaces with a damp cloth and polish with a soft dry cloth. To remove discoloration, use a nonabrasive cleaner. • After each "weekly" cleaning, the griddle must be seasoned again. If the griddle usage is very high, the "weekly" cleaning procedures may be done more often than once a week. The use of ice on the griddle plate to cool may damage the plate. 	Daily & Weekly
Catch Tray	Once the unit has cooled, remove the catch tray and discard the waste, grease, debris and crumbs. CAUTION: If the catch tray is permitted to fill too high, grease/debris is likely to accumulate under the unit. This catch tray/drawer is removed by pulling forward. USE CAUTION WHEN REMOVING!	As Needed

TROUBLESHOOTING

Problem	Possible Cause	Solution
Griddle not lighting	Main gas line is closed. Quick disconnect not inserted all the way. Pilot light is not lit. Cause unknown	Open Valve Check quick disconnect and make sure it is fully inserted into female coupling. Ignite pilot light. Call for service.
Flame is too high or too low	Adjustment knob is turned up or down	Adjust flame with control knob.
Pilot light not staying lit.	Flame is too low Pilot tube clogged.	Adjust pilot light flame height. Replace pilot tube. Call for service.
Strong smell of gas in cooking area.	Main gas line leak One or more of the pilot may be out and burner knob turned on.	Turn off main gas valve. DO NOT LIGHT FLAME, ignite anything, or turn/switch on anything electrical. Call Fire department if needed and call for service. Check to see if burners and pilots are lit. If not, turn off all burner valves and main gas valve and wait for excess gas to dissipate. Reattempt to light pilots after allowing excess gas to clear.
Cooking surface is heating up slowly.	Carbon buildup on griddle surface. Cause unknown	Clean griddle surface. Call for service.
Gas type of unit needs to be converted.	Unit ships from the factory Natural gas. Conversion from Natural Gas to L.P. is possible for this unit.	Call for service. This is not considered a warranty issue. Do not attempt conversion on your own.

If problems persist and the assigned solution does not remedy the issue, please call for service.

PARTS

NOTICE

INSTALLATION OF OTHER THAN GENUINE ENTREE PARTS WILL VOID THE WARRANTY ON THIS EQUIPMENT.

The serial plate is located on the inside, behind the front panel. Replacement parts may be ordered either through a ENTREE Authorized Parts Distributor or an ENTREE Authorized Service Agency

When ordering parts, please supply the Model Number, Serial Number, Part Number, and Description.

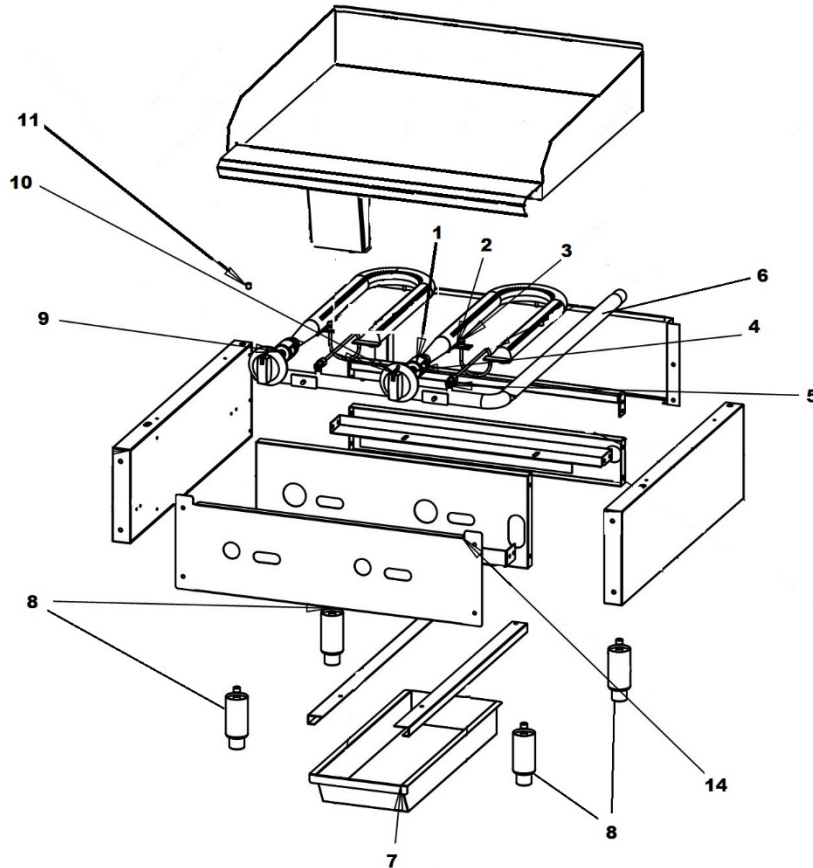

Ref #	Part #	Description	Ref #	Part #	Description
1	GC10001	U-SHAPED BURNER	8	GC10008	ADJUSTABLE LEG
2	GC10002	FIXED PLATE (PILOT)	9	GC10009	ORIFICE
3	GC10003	PILOT	10	GC10010	KNOB
4	GC10004	GAS VALVE	11	GC10011	PILOT PIN
5	GC10005	PILOT REGULATING VALVE	12	GC10012	GRIDDLE THERMOSTAT
6	GC10006	GAS INLET PIPE	*	GC10013	GRIDDLE THERMOSTAT DIAL
7	GC10007	DRIP PAN	*	GC10014	FRONT PANEL
*	GC10003.1	PILOT TUBING	*	GC10015	PRESSURE REGULATOR

*Griddle Thermostat and Dial are not shown.

GAS EQUIPMENT WARRANTY

(NON-TRANSFERABLE)

For Warranty Service Call (704) 900 2068

All new Entrée Gas Cooking Equipment is warranted to be free from defects in material and workmanship under normal use and service for a period of one (1) year from the date of original purchase, or 20 months after shipment date from the manufacturer, whichever occurs first. Any gas cooking equipment installed in a non-permanent structure, such as a mobile kitchen and/or trailer shall have a thirty (30) days limited warranty from the date of purchase. Proof of purchase required. Intended for indoor commercial use only.

This is limited to the repair and replacement, including labor charges of defective parts and/or assemblies. Labor, travel and mileage covered for the first year include straight time labor charges and travel charges within 100 miles, roundtrip.

1. This warranty is limited to original installation of new Entrée Gas Cooking Equipment for the original user in the United States or Canada. This warranty is not transferable.
2. This product **MUST** be installed per Local and National Codes as described in the Owner's/Installers Manual.
3. This warranty does not apply to any equipment that has not been installed in accordance with the directions published in the appropriate installation and operation manuals.
4. Entrée will bear no responsibility or liability for any equipment which has been mishandled, abused, misapplied, misused, subjected to harsh chemical action, or external causes such as gas fluctuations, field modified without the approval of Entrée, or by unauthorized personnel, improperly installed or maintained, equipment damaged by flood, fire, or other acts of God, or which have altered or missing serial numbers.
5. This warranty applies only to defects in parts and workmanship in equipment and not damage incurred in shipping, handling or excessive incoming gas pressure.
6. If the equipment has been changed, altered, modified, or repaired with parts not authorized or by a nonqualified Entrée Service Technician, then Entrée shall not be responsible for warranty claim.
7. Adjustments such as calibrations, leveling, tightening of fasteners and pipe unions, or utility connections normally associated with original installation are the responsibility of installer and not that of Entrée . Regular maintenance and cleaning shall be the responsibility of the customer.
8. Entrée will bear normal labor charges incurred in the repair or replacement of a warranted piece of equipment within 50 miles of an authorized service agent. Overtime, premium labor charges and travel charges in excess of 100 miles round trip will not be covered by Entrée and will be the responsibility of the person or firm requesting the service.
9. Original purchased replacement parts will be warranted for 90 days from the parts invoice date. This warranty is for parts cost only and does not include freight or labor charges.
10. This warranty provides the exclusive remedy against Entrée relating to all Entrée , whether in contract or in tort or under any other legal theory and whether arising out of warranties, representations, instructions, installations, or defects from any cause. Entrée shall not be liable, under any legal theory, for loss of use, revenue or profit, or for substitute use or performance, or for incidental, indirect, or special or consequential damages, or for any other loss of cost of similar type. The laws of some jurisdictions limit or do not allow the disclaimer of consequential damages. If the laws of such a jurisdiction apply to any claim by or against Entrée , NO limitations and disclaimers contained here shall be the greatest extent permitted by law.
11. The liability of Entrée is limited to the repair or replacement of any part found to be defective.

THIS WARRANTY AND THE LIABILITIES SET FORTH HEREIN ARE EXCLUSIVE AND IN LIEU OF ALL OF THEIR LIABILITIES AND WARRANTIES, EXPRESS OR IMPLIED, INCLUDING BUT NOT LIMITED TO, IMPLIED WARRANTIES OF MERCHANTABILITY AND FITNESS FOR PARTICULAR PURPOSE AND CONSTITUTES THE ONLY WARRANTY OF Entrée WITH RESPECT TO THE PRODUCT(S). Entrée LIABILITY ON ANY CLAIM, INCLUDING BUT NOT LIMITED TO NEGLIGENCE, SHALL NOT EXCEED THE PRICE OF THE EQUIPMENT THAT GIVES RISE TO THE CLAIM.

WARRANTY CLAIMS

All requests for Warranty Service must be called into (704) 900 2068 to obtain and agree to service dispatch with Warranty Claim Payment Terms. All claims for labor or parts must be made directly through Entrée L.L.C.

All claims should include: Dispatch number, model number of the unit, the serial number of the cabinet, proof of purchase, date of installation, and all pertinent information supporting the existence of the alleged defect.

WHAT IS NOT COVERED BY THIS WARRANTY

Entrée sole obligation under this warranty is limited to either repair or replacement of parts, subject to the additional limitations below. This warranty neither assumes nor authorizes any person to assume obligations other than those expressly covered by this warranty. Travel beyond 50 miles round trip and more than 2 hours round trip.

NO CONSEQUENTIAL DAMAGES. ENTRÉE IS NOT RESPONSIBLE FOR ECONOMIC LOSS; PROFIT LOSS; OR SPECIAL, INDIRECT, OR CONSEQUENTIAL DAMAGES, INCLUDING WITHOUT LIMITATION, LOSSES OR DAMAGES ARISING FROM FOOD OR PRODUCT SPOILAGE CLAIMS WHETHER OR NOT ON ACCOUNT OF REFRIGERATION FAILURE.

WARRANTY IS NOT TRANSFERABLE. This warranty is not assignable and applies only in favor of the original purchaser/user to whom delivered. **ANY SUCH ASSIGNMENT OR TRANSFER SHALL VOID THE WARRANTIES HEREIN MADE AND SHALL VOID ALL WARRANTIES, EXPRESS OR IMPLIED, INCLUDING ANY WARRANTY OF MERCHANTABILITY OR FITNESS FOR A PARTICULAR PURPOSE.**

IMPROPER USAGE. ENTRÉE ASSUMES NO LIABILITY FOR PARTS OR LABOR COVERAGE FOR COMPONENT FAILURE OR OTHER DAMAGES RESULTING FROM IMPROPER USAGE OR INSTALLATION OR FAILURE TO CLEAN AND/OR MAINTAIN PRODUCT AS SET FORTH IN THE OWNER'S MANUAL PROVIDED WITH THE UNIT.

RELOCATION OF EQUIPMENT FOR REPAIR: Entrée is not responsible for the cost to move the unit for any reason from its position of operation on the customer's premises to make a warranty repair.

RESIDENTIAL APPLICATIONS: Entrée assumes no liability for parts or labor coverage for component failure or other damages resulting from installation in non-commercial or residential applications.

ALTERATION, NEGLIGENCE, ABUSE, MISUSE, ACCIDENT, DAMAGE DURING TRANSIT OR INSTALLATION, FIRE, FLOOD, ACTS OF GOD.

Entrée is not responsible for the repair or replacement of any parts that Entrée determines have been subjected after the date of manufacture to alteration, neglect, abuse, misuse, accident, damage during transit or installation, fire, flood, or act of God.

IMPROPER GAS CONNECTIONS. ENTRÉE IS NOT RESPONSIBLE FOR THE REPAIR OR REPLACEMENT OF FAILED OR DAMAGED COMPONENTS RESULTING FROM INCORRECT PRESSURE OR TYPE OF GAS. THIS EQUIPMENT IS INTENDED FOR INDOOR USE ONLY.

NO IMPLIED WARRANTY OF MERCHANTABILITY OR FITNESS FOR A PARTICULAR PURPOSE: THERE ARE NO OTHER WARRANTIES, EXPRESSED, IMPLIED OR STATUTORY, EXCEPT THE ONE (1) YEAR PARTS & LABOR WARRANTY. THESE WARRANTIES ARE EXCLUSIVE AND IN LIEU OF ALL OTHER WARRANTIES, INCLUDING IMPLIED WARRANTY AND MERCHANTABILITY OR FITNESS FOR A PARTICULAR PURPOSE. THERE ARE NO WARRANTIES WHICH EXTEND BEYOND THE DESCRIPTION ON THE FACE HEREOF.

OUTSIDE U.S.: This warranty does not apply to, and Entrée is not responsible for, any warranty claims made on products sold or used outside the United States and Canada.



Commercial Cooking Equipment

INSTALLATION & OPERATION MANUAL

GAS COUNTER SERIES GRIDDLES

Warranty Service– Technical Support
(704) 900 2068

A product with the ENTREE name incorporates the best in durability and low maintenance. We all recognize, however, that replacement parts and occasional professional service may be necessary to extend the useful life of this unit. When service is needed, contact a ENTREE Authorized Service Agency, or your dealer. To avoid confusion, always refer to the Model Number, Serial Number, and Type of your unit.



Conforms to ANSI
STD Z83.11-2016
Certified to CSA STD
1.8-2016



Conforms to
NSF/ANSI STD.4

Entrée LLC ,4673 OSBORNE, DRIVE, SUITE D , EL PASO, TX 79922