



Gas Regulator Included

# COMMERCIAL GAS CHARBROILER



Model	Burners
BR-24	2
BR-36	3
BR-48	4

COUNTERTOP COOKING

The Entrée Gas Charbroiler radiates heat with efficient 12" U shaped burners that offer a high broiler flame every 6". This gives you flexibility and consistent heat distribution. Temperature controls every 12" allow you to cook larger or leaner pieces of meat like briskets, pork shoulders and ribs at low heat or crank up the intense heat to cook "Pittsburg Style" Ribeye, Sirloin or Prime Rib.

Entrée Charbroilers are available in 24", 36" and large 48" widths and covers complete parts and labor 1-year warranty.

Units are shipped for natural gas but are easily converted to LP (propane) gas with the LP conversion kit that is included.

All Charbroilers carry ETL gas and sanitation approvals that meet US gas and sanitation requirements for use in restaurants.

## STANDARD FEATURES

- High Performance and Efficient 35,000 BTU Stainless Steel U style burners provide flame every 6" on Charbroiler grates
- Heavy Duty 10 Gauge Stainless Steel Radiants for consistent heat distribution and non clog burner protection
- Heavy-Duty cast iron cooking racks, reversible to offer thick or thin Char-marks with 3 height positions
- 4" High Backsplash and Sidesplash protection against grease spatters
- Pilots with front access
- Extended cool to touch front edge
- Removable, easy to clean full width stainless grease catch pan
- All grates and radiants easily removable for easy cleaning
- Large knobs with set screws
- Adjustable non skid Stainless Steel legs

Warranty: Entrée's exclusive parts and labor FUSS warranty takes affect from 1 year after end user purchase.

\*Not suitable for installation in a non-commercial or residential applications.

Customer Service (704) 900-2068 - Fax (888) 388-6017 - [www:entree.biz](http://www.entree.biz)





# DETAILS AND DIMENSIONS

- A pressure regulator is provided with this unit.  
 Natural Gas 4.0" (102 mm) W.C.  
 Propane Gas 10.0" (279 mm) W.C.
- Gas connection is 3/4" NPT (19mm) rear gas connection.
- All equipment is supplied for Natural Gas, an LP conversion kit is also provided.

All Units

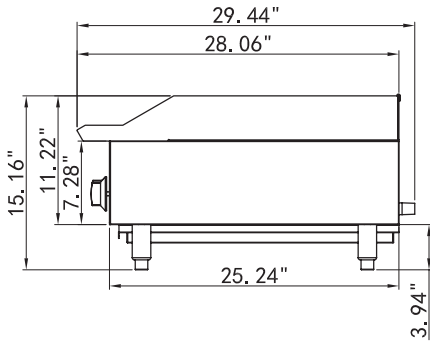

BR-24

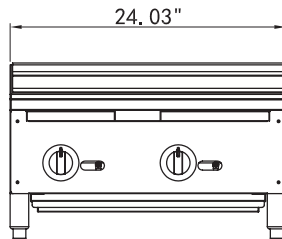

BR-24

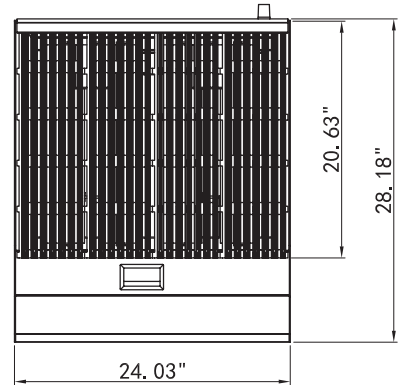

BR-36

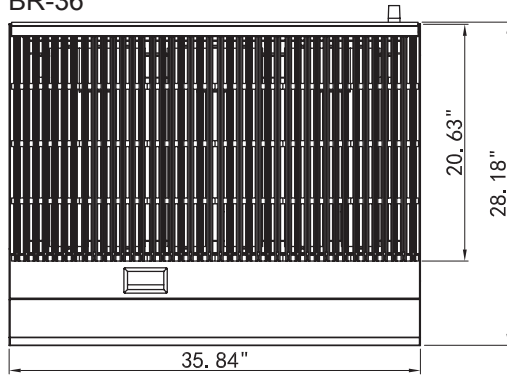

BR-36

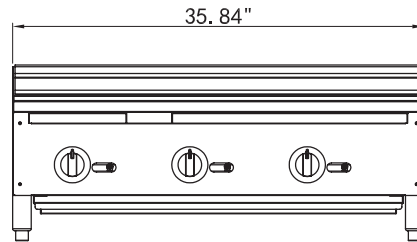

BR-48

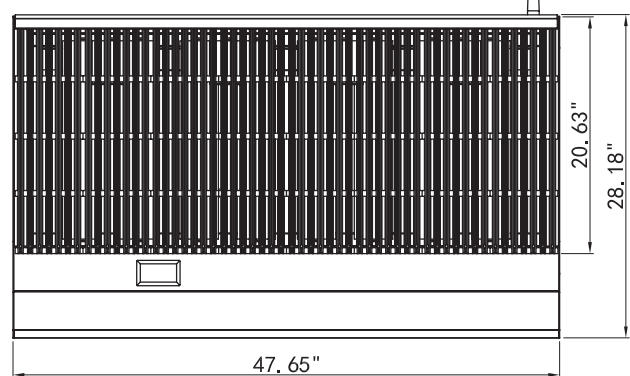

BR-48

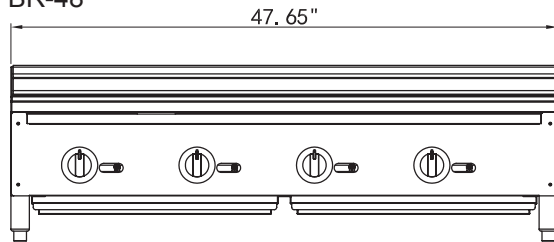

Model	Burners	Cooking Area		Controls	Dimensions			BTU's (per burner)	Total BTU's	Crated Weight (lbs)
		L	W		W	D	H			
BR-24	2	20.25	23.5	Manual	24.03	29.44	15.16	35,000	70,000	150
BR-36	3	20.25	35.5	Manual	35.84	29.44	15.16	35,000	105,000	218
BR-48	4	20.25	47.5	Manual	47.65	29.44	15.16	35,000	140,000	292